

Lori Epler,  
Chair  
Cumberland County

Roy Turner,  
Vice-Chair  
Cumberland County

Garland C. Hostetter,  
Town of Spring Lake  
Harvey Cain, Jr.,  
Town of Stedman  
Patricia Hall,  
Town of Hope Mills  
Charles C. Morris,  
Town of Linden



## COUNTY of CUMBERLAND

### *Planning & Inspections Department*

April 13, 2010

Thomas J. Lloyd,  
Director

Cecil P. Combs,  
Deputy Director

Walter Clark,  
Sara E. Piland,  
Cumberland County

Benny Pearce,  
Town of Eastover

Donovan McLaurin  
Wade, Falcon, & Godwin

### MEMORANDUM

**TO:** Cumberland County Joint Planning Board  
**FROM:** Planning & Inspections Staff  
**SUBJECT:** Staff Recommendation for April 20, 2010 Board Meeting

**P10-17:** REZONING OF 8.16+/- ACRES FROM R10 RESIDENTIAL TO R6A RESIDENTIAL/CUD CONDITIONAL USE DISTRICT FOR A 14 LOT SUBDIVISION AND THE PERMIT, OR TO A MORE RESTRICTIVE ZONING DISTRICT; LOCATED AT THE SOUTHEAST END OF SELMA DRIVE, EAST OF US HWY 301 (I-95 BUSINESS/GILLESPIE STREET); SUBMITTED BY WILBUR E. DEES FOR WEBTEC, INC (OWNER).

The Planning & Inspections Staff recommends approval of the requested rezoning to R6A Residential/CUD Conditional Use District (R6A/CUD) for the manufactured home residential subdivision based on the following:

1. Although the area in which the subject property is located generally is not consistent with the location criteria as listed in the Land Use Policies Plan of the 2030 Growth Vision Plan for "medium density residential," – primarily due to public sewer not being available and the site is not located within two miles of a public recreation area – the requested district and uses allowed within that district are consistent with the zoning and land uses immediately adjacent to the subject property;
2. The request is reasonable because it will allow for development comparable with the existing development in the immediate area and even though the subject property is located within the approach to Runway 10 at the Fayetteville Regional Airport, if approved, the request will ensure considerably less residential lots than what is currently allowed at this location resulting in an average lot size exceeding that allowed in the R20 district; and
3. Community water is available to the subject property.

The Planning & Inspections Staff also recommends approval of the Conditional Use Permit based on the following:

1. The use will not materially endanger the public health or safety if located according to the plan submitted, the proposed site layout of 14 residential lots is designed in such a manner that at a minimum the development standards of the ordinances will be met or exceeded, including County Environmental Health Department approval for the private septic tanks as addressed by Condition No. 2 of the attached *Ordinance Related Conditions*;

2. The use and the proposed development will meet all required conditions and specifications if developed according to the site plan, application and the attached *Ordinance Related Conditions*;
3. The use will maintain or enhance the value of adjoining or abutting properties if developed as proposed in that the property owner proposes a similar development to what is existing in the area and as a consequential benefit, the wetlands to the south and east of the subject property, undevelopable under current standards, will act as a natural buffer between the subject property and the existing development to the southeast; and
4. The location and character of the use, if developed according to the plan as submitted and recommended, will be in harmony with the area in which it is to be located – the adjacent Tanglewood Estates subdivision lots contain manufactured homes and the site in general will be developed in conformance with the development ordinances and adopted planning policies.

There are no other suitable zoning districts to be considered for this site.

The property owner who is also the developer has voluntarily agreed to this staff recommendation and all attached *Ordinance Related Conditions*.

Attachments:

- 1 – Site Profile
- 2 – Rezoning Sketch Map
- 3 – Site Plan
- 4 – Ordinance Related Conditions
- 5 – Application

**P10-17**  
**SITE PROFILE**

**P10-17:** REZONING OF 8.16+/- ACRES FROM R10 RESIDENTIAL TO R6A RESIDENTIAL/CUD CONDITIONAL USE DISTRICT FOR A 14 LOT SUBDIVISION AND THE PERMIT, OR TO A MORE RESTRICTIVE ZONING DISTRICT; LOCATED AT THE SOUTHEAST END OF SELMA DRIVE, EAST OF US HWY 301 (I-95 BUSINESS/GILLESPIE STREET); SUBMITTED BY WILBUR E. DEES FOR WEBTEC, INC (OWNER).

**Site Information:**

**Frontage & Location:** 60.00'+/- on SR 2316 (Selma Drive)

**Depth:** 640.00'+/-

**Jurisdiction:** Cumberland County

**Adjacent Property:** Yes, southwest of subject property

**Current Use:** Vacant residential & woodlands

**Initial Zoning:** R10 – March 15, 1979 (Area 6)

**Nonconformities:** None

**Zoning Violation(s):** None

**Surrounding Zoning:** North: M2, M(P), C(P), R10, R6A & RR; South: O&I(P), R10 & R6A; East: M(P) & R10; West: C(P) & R10

**Surrounding Land Use:** Residential (including manufactured homes), community utility station & woodlands

**2030 Land Use Plan:** Urban

**Special Flood Hazard Area (SFHA):** None

**Army Corp:** Wetlands may be present and if so, Sec 404 permit required

**Water/Sewer Availability:** Carolina Water/PWC

**Sewer Service Area:** No

**Soil Limitations:** Yes, hydric – JT Johnston Loam

**School Capacity/Enrolled:** Cashwell Elementary: 675/769; South View Middle: 900/725; South View High 1,800/1,838

**Subdivision/Site Plan:** If approved, “Ordinance Related Conditions” apply

**Municipal Influence Area:** City of Fayetteville

**Airport Overlay District:** Recommend disapproval of rezoning to a higher density district. Subject property is in runway approach

**Average Daily Traffic Count (2008):** 17,000 on US HWY 301 (I-95 Bus/Gillespie Street)

**Recreation Area:** Arnette Park located 4.1+/- miles away

**Highway Plan:** There are no road improvements/constructions specified for this area. This case has no impact on the current Highway Plan or Transportation Improvement Program

**Notes:**

1. Density:  
R10 – 47 Lots  
R6A – 89 Lots  
R6A (MHP) – 65 Units
2. Applicant’s request for R6A/CUD and Permit is limited to 14 lots

**First Class and Record Owners’ Mailed Notice Certification**

*A certified copy of the tax record owner(s) of the subject and adjacent properties and their tax record mailing address is contained within the case file and is incorporated by reference as if delivered herewith. The record owners’ acknowledgement of notice is also included in the case file.*

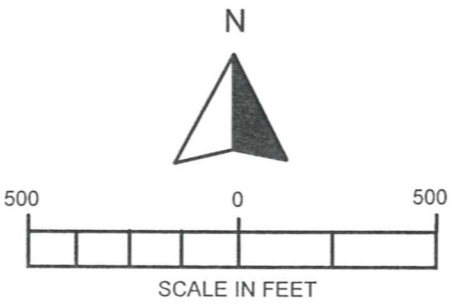
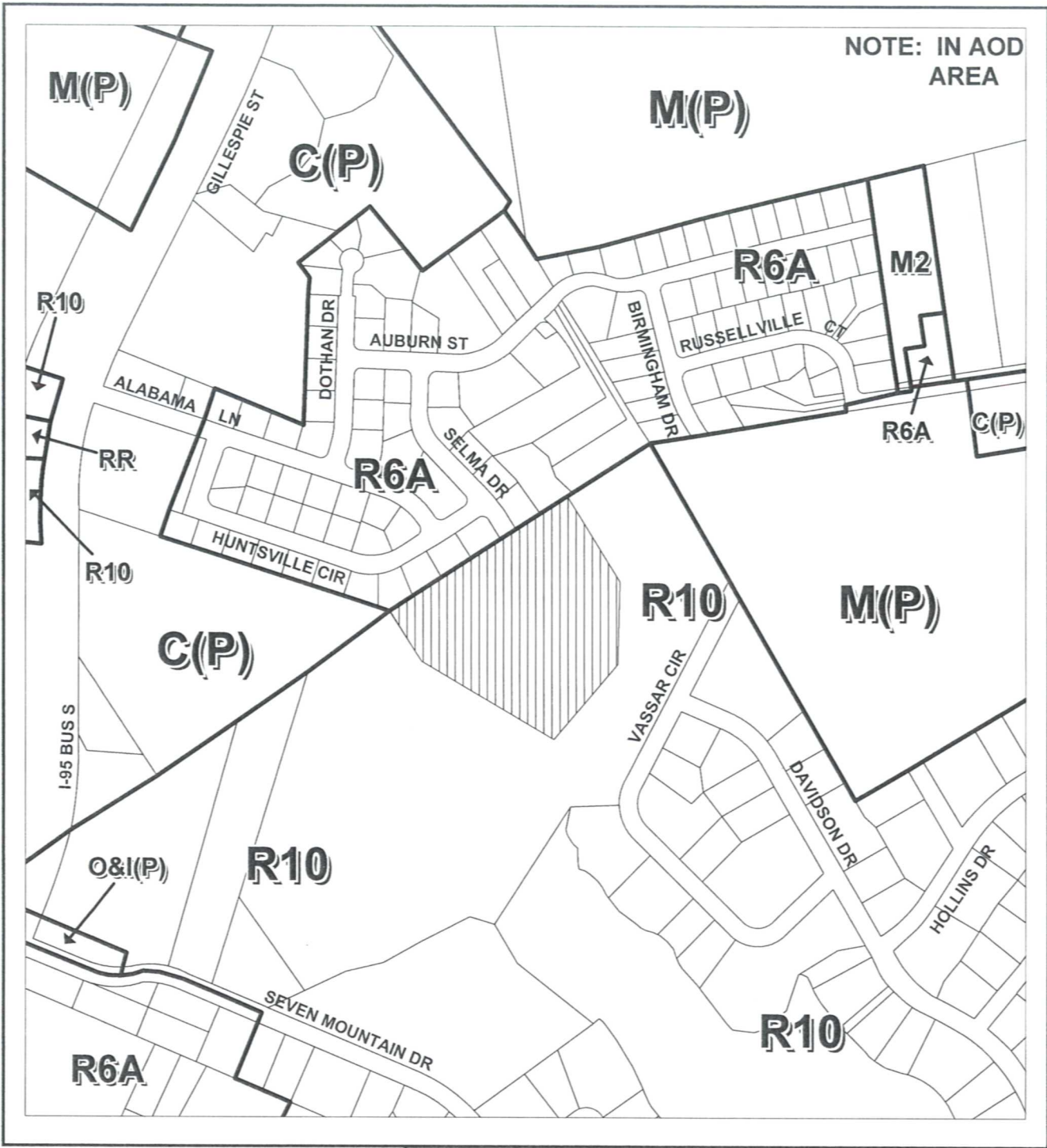

PORT. OF PIN: 0435-00-1681

## REQUESTED REZONING R10 TO R6A/CUD

ACREAGE: 8.16 AC.+/-		HEARING NO: P10-17	
ORDINANCE: COUNTY	HEARING DATE	ACTION	
STAFF RECOMMENDATION			
PLANNING BOARD			
GOVERNING BOARD			



PLAT BOOK 100  
PAGE 128

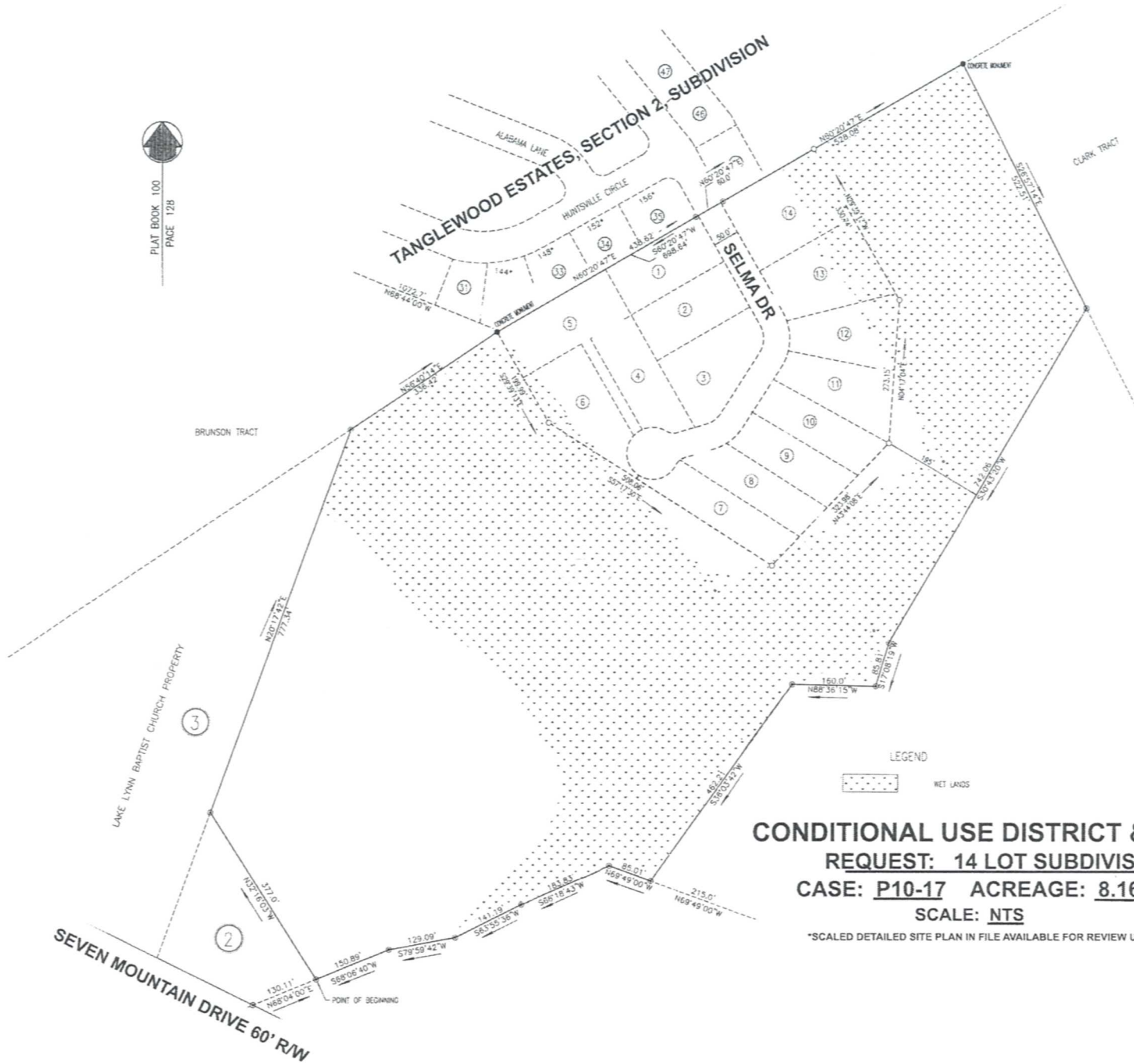

LEGEND



WET LANDS

**CONDITIONAL USE DISTRICT & PERMIT  
REQUEST: 14 LOT SUBDIVISION**

**CASE: P10-17 ACREAGE: 8.16 AC +/-**

**SCALE: NTS**

\*SCALED DETAILED SITE PLAN IN FILE AVAILABLE FOR REVIEW UPON REQUEST

SEVEN MOUNTAIN DRIVE 60' R/W

3/30/2010

4/13/2010

## **Conditional Use District**

### Ordinance Related Conditions

#### **Permit-Related:**

1. The owner/developer(s) of these lots must obtain detailed instructions on provisions of the County Zoning Ordinance and permits required to place any structure within this development from the County Code Enforcement Section, Room 101 in the Historic Courthouse at 130 Gillespie Street. For additional information, the developer should contact a Code Enforcement Officer.
2. The County Health Department must approve sewer plans prior to application for any permits. Site and soil evaluations must be conducted on the property by the County Environmental Health Department prior to application for permits. A copy of the Health Department approval must be provided to Code Enforcement at the time of application for any building/zoning permits. (Note: All Health Department requirements must be met prior to issuance of final permits.) (Section 2306 A, Water and Sewer, County Subdivision Ordinance)
3. Connection to public water is required; the Carolina Water Company must approve water plans prior to application for any permits. A copy of the Carolina Water Company's approval must be provided to Code Enforcement at the time of application for building/zoning permits. (Section 2306 A.1, Public Water and Sewer Systems County Subdivision Ordinance)
4. New development that will disturb one acre or more of land or is part of a larger plan that will disturb at least an acre of land is subject to the Post-Construction Stormwater Management Permitting Program (Phase II Stormwater Management Requirements) administered by the Division of Water Quality, North Carolina Department of Environment and Natural Resources. If one acre or more of land is to be disturbed, prior to the issuance of any building/zoning permits for this site, a copy of the State's *Post-Construction Permit* must be provided to County Code Enforcement.
5. For any new development, the developer must/may have to provide the Code Enforcement Section with an approved NC Department of Environment and Natural Resources (NCDENR) sedimentation and erosion control plan (S&E) prior to any application for permits. (Note: If any retention/detention basins are required for state approval of this plan, then three copies of a revised plan must be submitted and approved by Planning & Inspections prior to application for any building/zoning permits.) A copy of the NCDENR approval must be provided to Code Enforcement at the time of application for any building/zoning permits.
6. The developer must provide a site-specific address and tax parcel number at the time of building/zoning permit application.
7. The building final inspection cannot be accomplished until a Code Enforcement Officer inspects the site and certifies that the site is developed in accordance with the approved plans.

#### **Site-Related:**

8. All uses, dimensions, setbacks and other related provisions of the County Subdivision and Zoning Ordinances for the R6A/CUD zoning district must be complied with, as applicable.
9. Curbs and gutters must comply with the City of Fayetteville's street standards or the NC Department of Transportation, whichever is more stringent. Rolled concrete curb, if required, must not be less than 24 inches in width.
10. For any new development, an adequate drainage system must be installed by the developer in accordance with the NC Department of Environment and Natural Resources' (NCDENR) *Manual on Best Management Practices* and all drainage ways must be kept clean and free of debris. (Section 2306 D, County Subdivision Ordinance)
11. For new development, all utilities, except for 25kv or greater electrical lines, must be located underground. (Section 2306 C, County Subdivision Ordinance)

12. This review does not constitute a “subdivision” approval by NC Department of Transportation (NCDOT). A separate submittal to NCDOT will be required prior to consideration for addition to the system of any street within this development.
13. The developer is solely responsible for the maintenance and upkeep of the street until such time that the NCDOT formally accepts the street for maintenance purposes and adds it to the State system.
14. The developer must obtain a driveway permit from the NC Department of Transportation (NCDOT). A copy of the approved driveway permit must be provided to Code Enforcement at the time of application for building/zoning permits.
15. The NC Department of Transportation (NCDOT) must approve the street plans and the street(s) are required to be constructed to the City of Fayetteville or the NCDOT standards for secondary roads, whichever is the more stringent standard. Note: This condition includes that existing portion of Selma Drive that has not been accepted to the State system for maintenance purposes.
16. The developer must formally notify the NC Department of Transportation once construction of the public streets is complete and initiate the process of transferring the responsibility of road maintenance to the NCDOT. If application to the NCDOT District Engineer has not been formally submitted by the time building permits have been issued for 75% of the lots shown on the platted portion of the development, no additional building permits can be issued until the NCDOT District Engineer notifies this department of the receipt of the application.

**Plat-Related:**

17. Prior to submission for final plat approval, a concrete sidewalk must be constructed along one side of the proposed street and the sidewalk is required to comply with the specifications of the City of Fayetteville. [Co. Subdivision Ord., Sec. 2302, Area Specific Standards, A. Municipal Influence Area & Fayetteville Subdivision Ord., Sec. 25-61(5) Sidewalks].
18. Prior to submission for final plat approval, a fire hydrant must be installed along the proposed street; hydrants must be located no further than 1,000 feet apart and at a maximum of 500 feet from any lot. (Section 2306 B, Fire hydrants, County Subdivision Ordinance)
19. The developer must provide Lot 1 a minimum 20 feet of road frontage off of the proposed street between Lots 6 & 7 or recombine Lot 1 with the adjacent property under the same ownership (PIN: 0424-99-4729) to provide the required road frontage. (Note: The final plat must reflect which ever option the developer decides and include the entire properties involved.)
20. The “proposed street” must be labeled as “Selma Drive” on the final plat.
21. The final plat must be labeled as a “Zero Lot Line” development.
22. Prior to final plat approval of any portion of this development, the developer is required to submit a check or cash in the amount of \$496.80 (\$35.48 per lot/14 lots) payable to “Cumberland County”. This condition is in accordance with Section 2308, Parks, Recreation and Open Space, County Subdivision Ordinance, which requires every residential dwelling unit to provide a portion of land, in certain instances, or pay a fee in lieu of dedication, for the purposes of providing park, recreation and open space areas. (Park District #3)
23. The builder/developer must provide the buildable envelopes on the final plat: providing a five-foot maintenance easement along each side of all common internal lines with all other applicable setbacks being provided for; **or** at the time of permit application, the individual plot plans must be approved by Land Use Codes prior to issuance of any permits.
24. A minimum 10 foot wide utility easement is required along the rear lot lines and must be reflected on the final plat.
25. Any/All easements must be reflected on the final plat and labeled as to type of easement, reference number for document creating the easement, and the name of the agency, individual, etc. who holds the easement.
26. The NC Department of Transportation (NCDOT) stamp must be affixed to the final plat prior to submission for final plat approval by Land Use Codes.
27. The notarized signature(s) of all current tax record owner(s) and notary certifications appear on the final plat when submitted for final approval. (Section 2503 D, Certificate of Ownership and Dedication, County Subdivision Ordinance)

28. The developer is reminded that the improvements must be in place or that final plat approval will only be granted in accordance with Section 2502 B, C, or D, Final Plat – Guarantees of Improvements, Subdivision Ordinance. (Note: Once the improvements are in place, the developer is responsible for contacting Jeff Barnhill to schedule an inspection of the improvements.)
29. The final plat must be submitted to Land Use Codes for review and approval for recording with the County Register of Deeds, and the plat must be recorded prior to any permit application for any structure and/or prior to the sale of any lot or unit within this development.

**Plat-Required Statements:**

30. Since this development does not have public sewer, the following disclosure statement is required to be provided on the final plat (Section 2504 C, On-Site Water and/or Sewer Discloser, County Subdivision Ordinance):

“The individual lots in this development do not have public sewer, and no lots have been approved by the Health Department for on-site sewer services at the date of this recording.”

31. All structures shall be shown on the final plat or the final plat shall reflect the following statement (Section 2504 D, County Subdivision Ordinance):

“Nonconforming structures have not been created by this subdivision.”

32. Since this development is located within the *Airport Overlay District* as shown on the official zoning map, the following disclosure statement is required to be provided on the final plat (Section 8.101.E, Notice and Disclosure of Noise Impact Discloser, County Zoning Ordinance):

“Property shown on this plan/plat is within the Cumberland County Airport Overlay District and all or a portion of the property described hereon is within an area that is subject to an average noise level near to or exceeding 65 dnl.”

**Other Relevant Conditions:**

33. The applicant is advised to consult an expert on wetlands before proceeding with any development. There may be wetlands located in the project area that are subject to the permit requirements of Section 404 of the Clean Water Act. To avoid a violation of federal and/or state law, it is recommended the developer contact the Office of the Army Corp of Engineers or hire an environmental consultant to identify and delineate any wetlands in the project area prior to construction. A Section 404 permit will be required if the applicant needs to fill wetlands and the permit must be obtained prior to any construction on this site.
34. The owner/developer is responsible for ensuring easements which may exist on the subject property are accounted for, not encumbered and that no part of this development is violating the rights of the easement holder.
35. Because the subject property is located within the Airport Overlay District, the developer and is strongly encouraged to discuss their development plans with Land Use Codes Section and/or the Fayetteville Regional Airport Director early in the planning stage to ensure that the proposed height of any proposed structure can be found to be no obstruction or hazard to air navigation. The developer is also reminded to relay this information to future lot owners.
36. The owner/developer be aware that every deed created for a lot being served by an on-site sewer system must contain the following disclosure when filed with the County Register of Deeds:

“Public sewer services are not available as of the date of the recording of this deed. On-site sewer disposal systems must be approved by the County Health Department.”

**If you need clarification of any conditions, please contact Ed Byrne at 910-678-7609 or Patti Speicher at 910-678-7605; otherwise, contact the appropriate agency at the contact numbers below.**



Contact Information (Area Code is 910 unless otherwise stated):

Improvements Inspections:	Jeff Barnhill	678-7765
Subdivision/Site Plan/Plat	Ed Byrne	678-7609
Code Enforcement (Permits):	Ken Sykes	321-6654
County Health Department:	Daniel Ortiz	433-3680
Carolina Water Services of NC:	Kerry Jordan	800-348-2383
Fayetteville Planning:	Marsha Bryant	433-1416
Fayetteville Engineer (Easements):	Rusty Thompson	433-1660
Fayetteville Engineer (Sidewalks):	Randy Lane	433-1661
Fayetteville Engineer (Stormwater):	Jeffrey Brown	433-1691
County Public Utilities:	Tom Cooney	678-7682
Corp of Engineers (wetlands):	Crystal C. Amschler	(910) 251-4170
NCDENR (E&S):	Sally McKinney	433-3300
E911 Site-Specific Address:	Ron Gonzales	678-7616
Tax Parcel Numbers:		678-7549
NCDOT (driveways/curb-cuts):	Gary Burton	486-1496
NCDOT (subdivision roads):	David Plummer	486-1496
N.C. Division of Water Quality:	Mike Randall	(919) 733-5083 ext. 545

cc: Marsha Bryant, City of Fayetteville

TO THE CUMBERLAND COUNTY JOINT PLANNING BOARD AND THE BOARD OF COUNTY COMMISSIONERS OF CUMBERLAND COUNTY, NC:

I (We), the undersigned, hereby submit this application, and petition the County Commissioners to amend and to change the zoning map of the County of Cumberland as provided for under the provisions of the County Zoning Ordinance. In support of this petition, as hereinafter requested, the following facts are submitted:

1. APPLICANT/AGENT: Wilbur Eugene Dees
2. ADDRESS: 2927 Middlesex Road ZIP CODE: 28306
3. TELEPHONE: (Home) 910-425-1941 (Work) 910-624-4779 <sup>cell</sup>
4. Location of Property: End of Selma Drive in Tanglewood Subdivision
5. Parcel Identification Number (PIN #) of subject property: 0435-00-1681  
(also known as Tax ID Number or Property Tax ID)
6. Acreage: ~~34.99~~ 3.16 <sup>1/80 3/25/2010</sup> Frontage: 60 ft. Depth: see "plat"
7. Water Provider: Carolina Water
8. Septage Provider: Individual Septic Systems
9. Deed Book 7343, Page(s) 055, Cumberland County Registry. (Attach copy of deed of subject property as it appears in Registry).
10. Existing use of property: Vacant
11. Proposed use(s) of the property: Residential

**NOTE: Be specific and list all intended uses.**

12. It is requested that the foregoing property be rezoned FROM: R10

TO: (select one)

- Conditional Use District, with an underlying zoning district of R64  
(Article V) R6A
- Mixed Use/Conditional Use District (Article VI)
- Planned Neighborhood District/Conditional Use District (Article VII)
- Density Development/Conditional Use District, at the \_\_\_\_\_ Density  
(Article VIII)

APPLICATION FOR  
CONDITIONAL USE PERMIT

1. PROPOSED USE(S):

- A. List the use(s) proposed for the Conditional Use Permit. (Use of the underlying district will be restricted only to the use(s) specified in this application.)

See Site Plan

- B. Density: List the amount of acreage that will be residential, commercial, and/or open space, and the number of lots and/or dwelling units proposed, and the square footage of the non-residential units.

8.16 Acres

14 Lots

$14 / 8.16 = 1.72$  Lots Per Acre

2. DIMENSIONAL REQUIREMENTS:

- A. Reference either the dimensional requirements of the district, Sec. 1104 or list the proposed setbacks.

FY - 35'

SY - 10'

BY - 30'

- B. Off-street parking and loading, Sec. 1202: List the number of spaces, type of surfacing material and any other pertinent information.

3. SIGN REQUIREMENTS: None

Reference the district sign regulations proposed from Article XIII.

4. LANDSCAPE AND BUFFER REQUIREMENTS:

- A. For all new non-residential and mixed use development abutting a public street, indicate the number and type of large or small ornamental trees used in the streetscape, yard space, and/or parking areas, plus the number and type of shrubs (Sec. 1102N). **NOTE: All required landscaping must be included on the site plan.**

N/A

- B. Indicate the type of buffering and approximate location, width and setback from the property lines.

N/A

5. MISCELLANEOUS:

List any information not set forth above, such as the days and hours of the operation, number of employees, exterior lighting, noise, odor and smoke, emission controls, etc.

N/A

6. SITE PLAN REQUIREMENTS:

The application shall include a site plan drawn to the specifications of Sec. 1402. If the proposed uses involve development subject to the County Subdivision Ordinance, the site plan required may be general in nature, showing a generalized street pattern, if applicable, and the location of proposed uses. If the proposed uses include development not subject to the Subdivision Ordinance, the site plan shall be of sufficient detail to allow the Planning and Inspections Staff and the Planning Board to analyze the proposed uses and arrangement of uses on the site. It shall also include the footprints of all buildings (proposed and existing), the proposed number of stories, location and number of off-street parking and loading spaces, proposed points of access to existing streets and internal circulation patterns. In addition, the location of all proposed buffers and fences and landscaping shall be included on the site plan.

7. ACKNOWLEDGEMENT:

It is understood by the undersigned that the official zoning map, as originally adopted and subsequently amended, is presumed to be appropriate to the property involved and that the burden of proof for a zoning amendment (change) rests with the petitioner.

It is the responsibility of the petitioner (personally or by agent) to submit to the Planning and Inspections Department a valid request, not incompatible with existing neighborhood zoning patterns.

In order for the Planning Board to offer a favorable recommendation, and for the Board of Commissioners to approve, any Conditional Use District and Permit they must find from the evidence presented at their respective public hearing that:

- A. The use will not materially endanger the public health or safety if located according to the plan submitted and recommended;
- B. The use meets all required conditions and specifications;
- C. The use will maintain or enhance the value of adjoining or abutting properties, or that the use is a public necessity; and
- D. The location and character of the use, if developed according to the plan as submitted and recommended, will be in harmony with the area in which it is to be located and in general conformity with Cumberland County's most recent Comprehensive Land Use Plan and adopted planning policies.

I further understand I must voluntarily agree to all conditions proposed for the Conditional Use Permit.

The undersigned hereby acknowledge that the Planning and Inspections Staff has conferred with the petitioner or assigns, and the application as submitted is accurate and correct.

WEDTEC, INC., P.A.  
NAME OF OWNERS (PRINT OR TYPE)

2927 MIDDLESEX ROAD, FAYETTEVILLE, N.C.  
ADDRESS OF OWNER(S)

910-425-1941  
HOME TELEPHONE #

910-624-4779  
WORK TELEPHONE #

*Willy B. ...*      *Pres.*  
SIGNATURE OF OWNER(S)      SIGNATURE OF OWNER(S)

Lori Epler,  
Chair  
Cumberland County

Roy Turner,  
Vice-Chair  
Cumberland County

Garland C. Hostetter,  
Town of Spring Lake  
Harvey Cain, Jr.,  
Town of Stedman  
Patricia Hall,  
Town of Hope Mills  
Charles C. Morris,  
Town of Linden



## COUNTY of CUMBERLAND

### *Planning & Inspections Department*

April 13, 2010

Thomas J. Lloyd,  
Director

Cecil P. Combs,  
Deputy Director

Walter Clark,  
Sara E. Piland,  
Cumberland County

Benny Pearce,  
Town of Eastover

Donovan McLaurin  
Wade, Falcon, & Godwin

### **MEMORANDUM**

**TO:** Cumberland County Joint Planning Board

**FROM:** Planning & Inspections Staff

**SUBJECT:** Staff Recommendation for April 20, 2010 Board Meeting

**P10-14:** REZONING OF .44+/- ACRES FROM C1(P) PLANNED LOCAL BUSINESS/CUD CONDITIONAL USE DISTRICT FOR AN OFFICE AND R10 RESIDENTIAL TO C1(P) PLANNED LOCAL BUSINESS OR TO A MORE RESTRICTIVE ZONING DISTRICT, LOCATED AT 4300 AND 4310 CUMBERLAND ROAD, SUBMITTED BY DREW AND KATHRENE BOXWELL (OWNERS).

The Planning & Inspections Staff recommends approval of the request for C1(P) Planned Local Business District based on the following:

1. Although the district requested is not entirely consistent with the location criteria for planned local business as listed in the Land Use Policies Plan of the 2030 Growth Vision Plan because public sewer is required but not available, the request is reasonable due to the subject property being predominantly surrounded by commercial and industrial zoning and uses;
2. The area is transitioning to primarily non-residential uses at this location; and
3. The subject property is located on a major thoroughfare.

There are no other districts considered suitable for this request.

Attachments:

- 1 – Site Profile
- 2 – Sketch Map

**P10-14**  
**SITE PROFILE**

**P10-14:** REZONING OF .44+/- ACRES FROM C1(P) PLANNED LOCAL BUSINESS/CUD CONDITIONAL USE DISTRICT FOR AN OFFICE AND R10 RESIDENTIAL TO C1(P) PLANNED LOCAL BUSINESS OR TO A MORE RESTRICTIVE ZONING DISTRICT, LOCATED AT 4300 AND 4310 CUMBERLAND ROAD, SUBMITTED BY DREW AND KATHRENE BOXWELL (OWNERS).

**Site Information:**

**Frontage & Location:** 124.00'+/- on SR 1141 (Cumberland Road)

**Depth:** 135.00'+/-

**Jurisdiction:** Cumberland County

**Adjacent Property:** No

**Current Use:** Real Estate Office & Vacant Residential

**Initial Zoning:** R10 – August 1, 1975 (Area 3); rezoned to C1(P)/CUD on May 15, 2006

**Nonconformities:** If approved, existing structure will not be able to meet side setbacks (approximately 10.00' from side property line)

**Zoning Violation(s):** None

**Surrounding Zoning:** North: R10 (Fayetteville), R6A (Fayetteville) & R6 (Fayetteville); South: C3, C1(P), R10, R6A & RR; East: C3, C1(P), R10 & R6A; West: C(P)/CUD {C(P) Uses w/ exclusions}, C3, C(P), C1(P), R10 & R6A

**Surrounding Land Use:** Residential (including manufactured homes & multi-family), cemetery, night club, motor vehicle repair (2), monument sales, motor vehicle sales, barbering, religious worship & woodlands

**2030 Land Use Plan:** Urban

**Cumberland Road Study:** Low density residential

**Special Flood Hazard Area (SFHA):** None

**Water/Sewer Availability:** PWC/Septic

**Soil Limitations:** None

**School Capacity/Enrolled:** Sherwood Park Elementary: 540/617; Ireland Drive Middle (6): 340/332; Douglas Byrd Middle (7-8): 600/644; Douglas Byrd High: 1280/1311

**Subdivision/Site Plan:** Site plan required for any change-in-use or new construction if approved

**Municipal Influence Ares:** Town of Hope Mills

**Average Daily Traffic Count (2008):** 23,000 on SR 1141 (Cumberland Road)

**Highway Plan:** Cumberland Road is identified in the highway plan as a major thoroughfare. This is a multi-lane facility (U-22304) with an adequate right-of-way of 90 feet. Road improvements have been completed

**Note:**

Minimum Yard Setback Regulations:

**C1(P)**

Front yard: 45'

Side yard: 15'

Rear yard: 20'

Existing Structure Setbacks:

Front yard: 34.8'

Side Yard (West): 7'

Side Yard (East): 27.9'

Rear Yard: 76.4'

**First Class and Record Owners' Mailed Notice Certification**

*A certified copy of the tax record owner(s) of the subject and adjacent properties and their tax record mailing address is contained within the case file and is incorporated by reference as if delivered herewith. The record owners' certified receipt of notice is also included.*

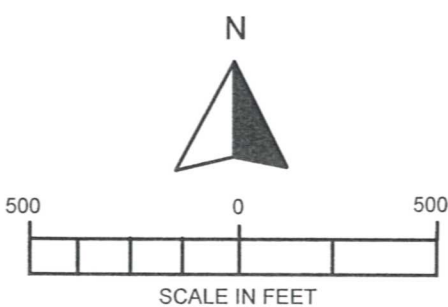
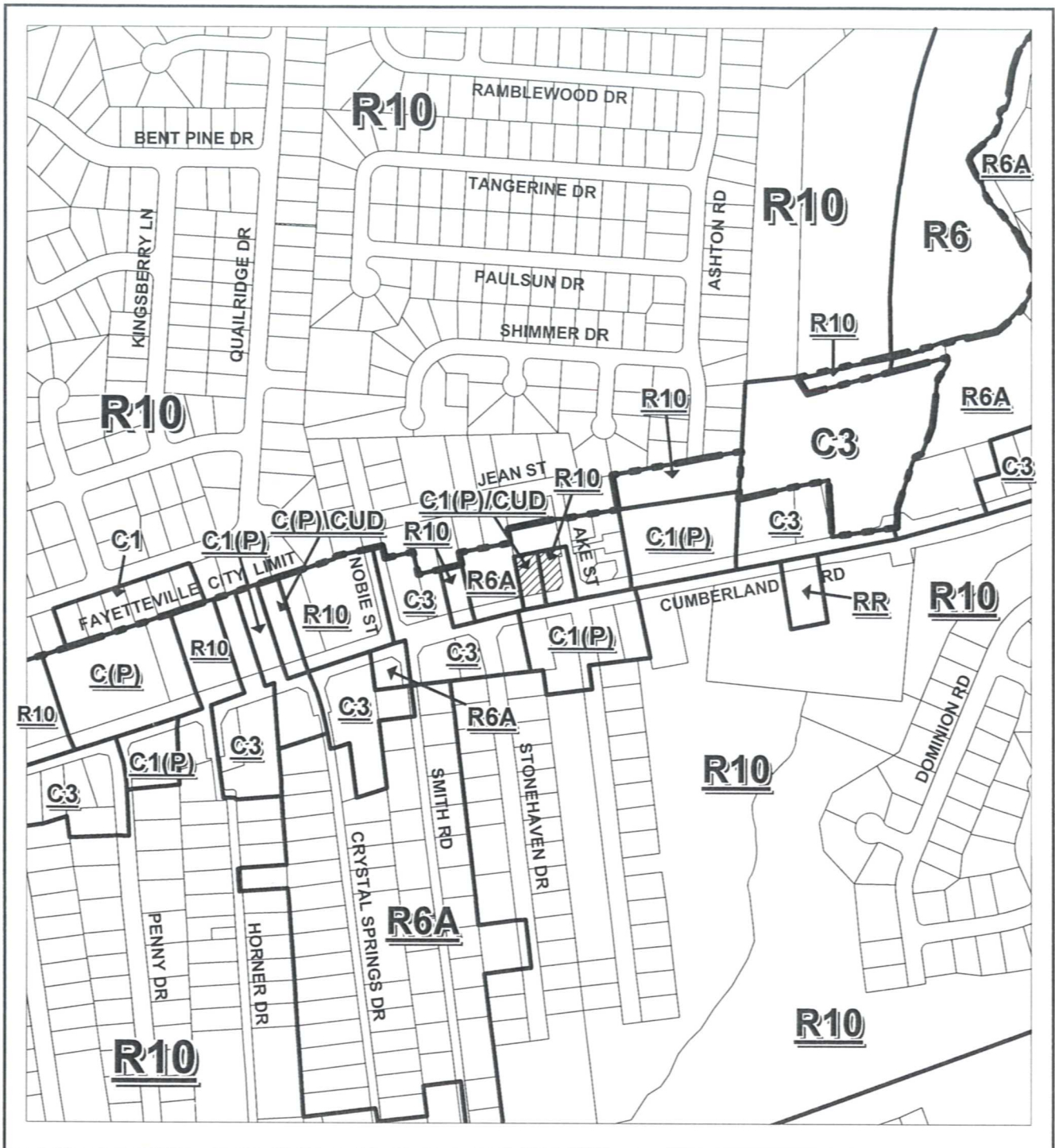

## REQUESTED REZONING C1(P)/CUD & R10 TO C1(P)

<b>ACREAGE: 0.44 AC.+/-</b>	<b>HEARING NO: P10-14</b>	
<b>ORDINANCE: COUNTY</b>	<b>HEARING DATE</b>	<b>ACTION</b>
<b>STAFF RECOMMENDATION</b>		
<b>PLANNING BOARD</b>		
<b>GOVERNING BOARD</b>		

PIN: 0415-38-5693  
PIN: 0415-38-6674



Lori Epler,  
Chair  
Cumberland County

Roy Turner,  
Vice-Chair  
Cumberland County

Garland C. Hostetter,  
Town of Spring Lake  
Harvey Cain, Jr.,  
Town of Stedman  
Patricia Hall,  
Town of Hope Mills  
Charles C. Morris,  
Town of Linden



## COUNTY of CUMBERLAND

### *Planning & Inspections Department*

April 13, 2010

Thomas J. Lloyd,  
Director

Cecil P. Combs,  
Deputy Director

Walter Clark,  
Sara E. Piland,  
Cumberland County

Benny Pearce,  
Town of Eastover

Donovan McLaurin  
Wade, Falcon, & Godwin

### **MEMORANDUM**

**TO:** Cumberland County Joint Planning Board  
**FROM:** Planning & Inspections Staff  
**SUBJECT:** Staff Recommendation for April 20, 2010 Board Meeting

**P10-16:** REZONING OF .14+/- ACRES FROM C1(P) PLANNED LOCAL BUSINESS AND R6A RESIDENTIAL TO R6 RESIDENTIAL OR TO A MORE RESTRICTIVE ZONING DISTRICT, LOCATED AT 5448 PARKTON ROAD, SUBMITTED BY MARY L. STEVENSON (OWNER) AND GENE G. WOLF.

The Planning & Inspections Staff recommends approval of the request for R6 Residential District based on the following:

1. Although the district requested is not entirely consistent with the location criteria for medium density residential as listed in the Land Use Policies Plan of the 2030 Growth Vision Plan because public sewer is required but not available, the request is reasonable due the subject property being predominantly surrounded by medium and low density residential zoning and uses;
2. The request is consistent with the surrounding land use; and
3. The subject property is located on a major thoroughfare.

There are no other districts considered suitable for this request.

#### Attachments:

- 1 – Site Profile
- 2 – Sketch Map

**P10-16**  
**SITE PROFILE**

**P10-16:** REZONING OF .14+/- ACRES FROM C1(P) PLANNED LOCAL BUSINESS AND R6A RESIDENTIAL TO R6 RESIDENTIAL OR TO A MORE RESTRICTIVE ZONING DISTRICT, LOCATED AT 5448 PARKTON ROAD, SUBMITTED BY MARY L. STEVENSON (OWNER) AND GENE G. WOLF.

**Site Information:**

**Frontage & Location:** 90.00'+/- on SR 1118 (Parkton Road)

**Depth:** 48.75'+/-

**Jurisdiction:** Cumberland County

**Adjacent Property:** No

**Current Use:** Residential

**Initial Zoning:** C1 & R6A – February 3, 1977 (Area 7)

**Nonconformities:** Existing structure does not appear to meet rear setbacks (approximately 5.00' from rear property line), nonconformity will increase if approved

**Zoning Violation(s):** None

**Surrounding Zoning:** North: R20, R10 & R6A; South: RR/CU (to allow tool & die business), R10, R6A, RR & CD; East: R10; West: C1(P) & R6A

**Surrounding Land Use:** Residential (including manufactured dwellings), religious worship & vacant commercial

**2030 Land Use Plan:** Urban fringe

**Special Flood Hazard Area (SFHA):** None

**Water/Sewer Availability:** Well/Septic

**Soil Limitations:** None

**School Capacity/Enrolled:** Gallberry Farm Elementary: 900/790; Gray's Creek Middle: 1000/861; Gray's Creek High: 1270/1219

**Subdivision/Site Plan:** Review required prior to additional development

**Municipal Influence Area:** Town of Hope Mills

**Average Daily Traffic Count (2008):** 3,100 on SR 1118 (Parkton Road)

**Recreation Area:** Hope Mills Park located 2.50+/- miles away

**Highway Plan:** Parkton Road is identified in the Highway Plan as a major thoroughfare. This proposal calls for a multi-lane facility (4 lane-divide). Road Improvements are not included in the 2009-2015 MTIP. This is a Priority #2 Project under the LRTP

- Notes:**
1. Density:  
R6 – 1 unit
  
  2. Minimum Yard Setback Regulations:

<u>C1(P)</u>	<u>R6A</u>	<u>R6</u>
Front yard: 45'	Front yard: 25'	Front yard: 25'
Side yard: 15'	Side yard: 10'	Side yard: 10'
Rear yard: 20'	Rear yard: 15'	Rear Yard: 30'

**First Class and Record Owners' Mailed Notice Certification**

*A certified copy of the tax record owner(s) of the subject and adjacent properties and their tax record mailing address is contained within the case file and is incorporated by reference as if delivered herewith. The record owners' acknowledgement of notice is also included in the case file.*

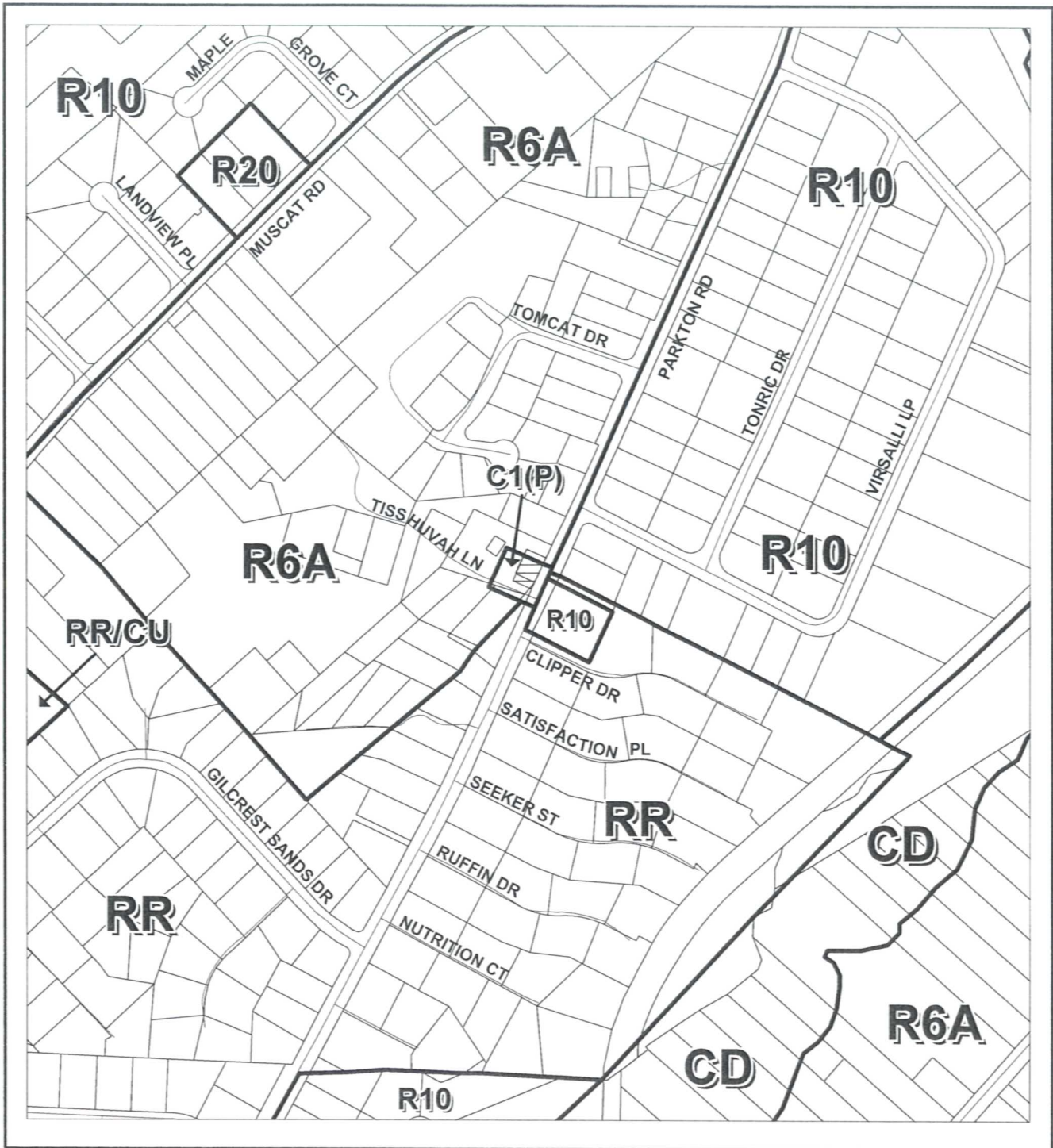

## REQUESTED REZONING C1(P) & R6A TO R6

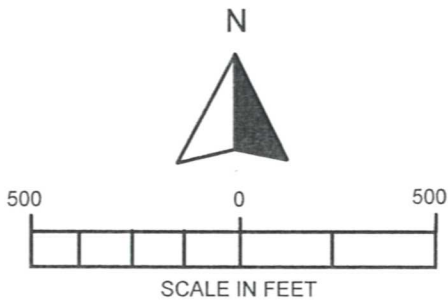

PIN: 0413-56-4918

ACREAGE: 0.14 AC.+/-		HEARING NO: P10-16	
ORDINANCE: COUNTY		HEARING DATE	ACTION
STAFF RECOMMENDATION			
PLANNING BOARD			
GOVERNING BOARD			

## SUBDIVISION WAIVER – SITE PROFILE

**CASE NO. 10-029.** CONSIDERATION OF THE KIDZ KASTLE DAYCARE REQUEST FOR A WAIVER FROM THE REQUIREMENT TO INSTALL A FIRE HYDRANT [COUNTY SUBDIVISION ORDINANCE, SECTION 2302, AREA-SPECIFIC STANDARDS, A. MUNICIPAL INFLUENCE AREAS AND SECTION 86-128(A)(1), FIRE HYDRANTS, HOPE MILLS CHAPTER(1985 VERSION)]; ZONING: R10; TOTAL ACREAGE: 0.63 +/-; LOCATED AT 4820 CAMDEN ROAD; SUBMITTED BY WILLIAM & ANGELA WRIGHT (OWNERS). (COUNTY JURISDICTION/HOPE MILLS MIA)

### Summary of Request

Developer was approved by the County Board of Adjustment for a day care facility expansion on 10-15-09 (Case: P09-08-C). Under the Ordinance Related Conditions (No. 23) the developer is required to install a fire hydrant within 500 feet of this site since this site is served by public water. The developer has requested a waiver from this condition because the Aqua Water Company states the system can't provide for fire suppression since it has a hydropneumatic tank for water storage.

### Site Information

**Frontage:** 259.69' +/- on SR 1003 (Camden Road)

**Depth:** 132.40' +/-

**Current Use:** Children's Daycare Facility

**Adjacent Property:** No

**Special Flood Hazard Area (SFHA):** No

**Water/Sewer Availability:** Aqua Water Company/Septic – community water and septic system existing on the subject property.

**Soil Limitations:** None

**Municipal Influence Area:** Town of Hope Mills

### Applicable County Subdivision Ordinance Provision

Section 2302 A, *Municipal Influence Areas*. The Board of Commissioners by interlocal agreement may approve and establish a Municipal Influence Area (MIA) for a municipality. All development located within a municipality's MIA shall be developed in accordance with the subdivision design standards officially adopted by the municipality, except as provided in any interlocal agreement adopted by the affected governing bodies. The development standards for each municipality are attached to this ordinance as "Exhibit 5" and entitled MIA Development Standards. The official MIA map – see Exhibit 4 – shall be maintained by the Planning and Inspections Department and kept on file with the office of the Clerk to the County Board of Commissioners.

### Applicable Hope Mills Subdivision Chapter Provision

Section 86-128(a)(1), *Fire Hydrants*. Fire hydrants are required when a development subject to this Code is located in the town or the town municipal influence area and the subdivision is to be served by a public or community water system.

1. Fire hydrants shall be located no more than 1,000 feet apart and at a maximum of 500 feet from any residential or commercial lot;

### Attachments

- 1 – Sketch Map
- 2 – Site Plan
- 3 – Aerial Map
- 4 – Letter of Approval, dated 10-28-09
- 5 – Application with Aqua Water Company and PWC letters

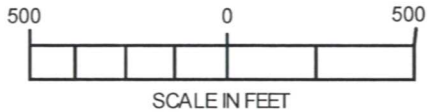
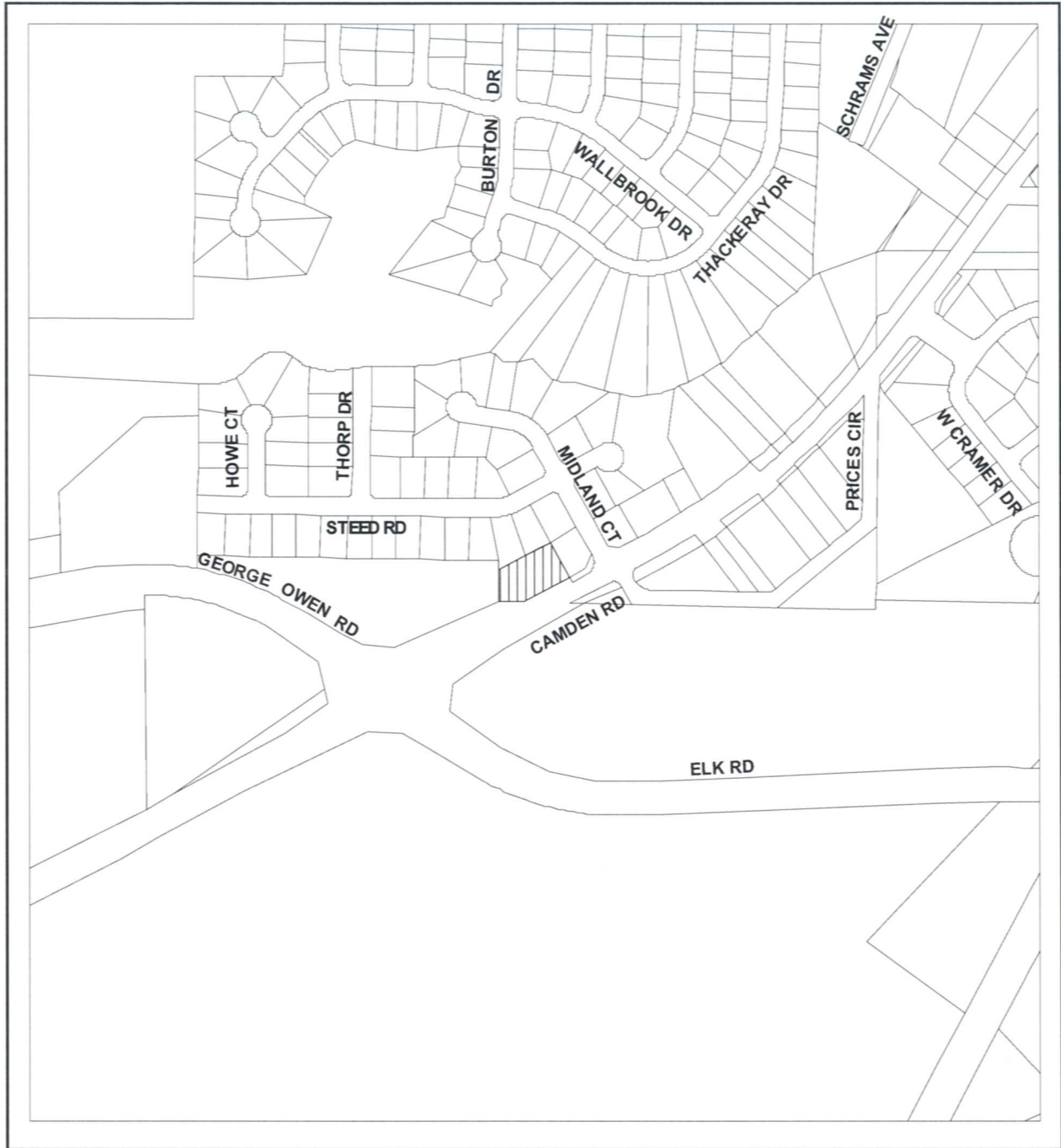

## COUNTY SUBDIVISION ORDINANCE WAIVER

<b>ACREAGE: 0.63 AC.+/-</b>	<b>HEARING NO: 10-029</b>	
ORDINANCE COUNTY	HEARING DATE	ACTION
GOVERNING BOARD		

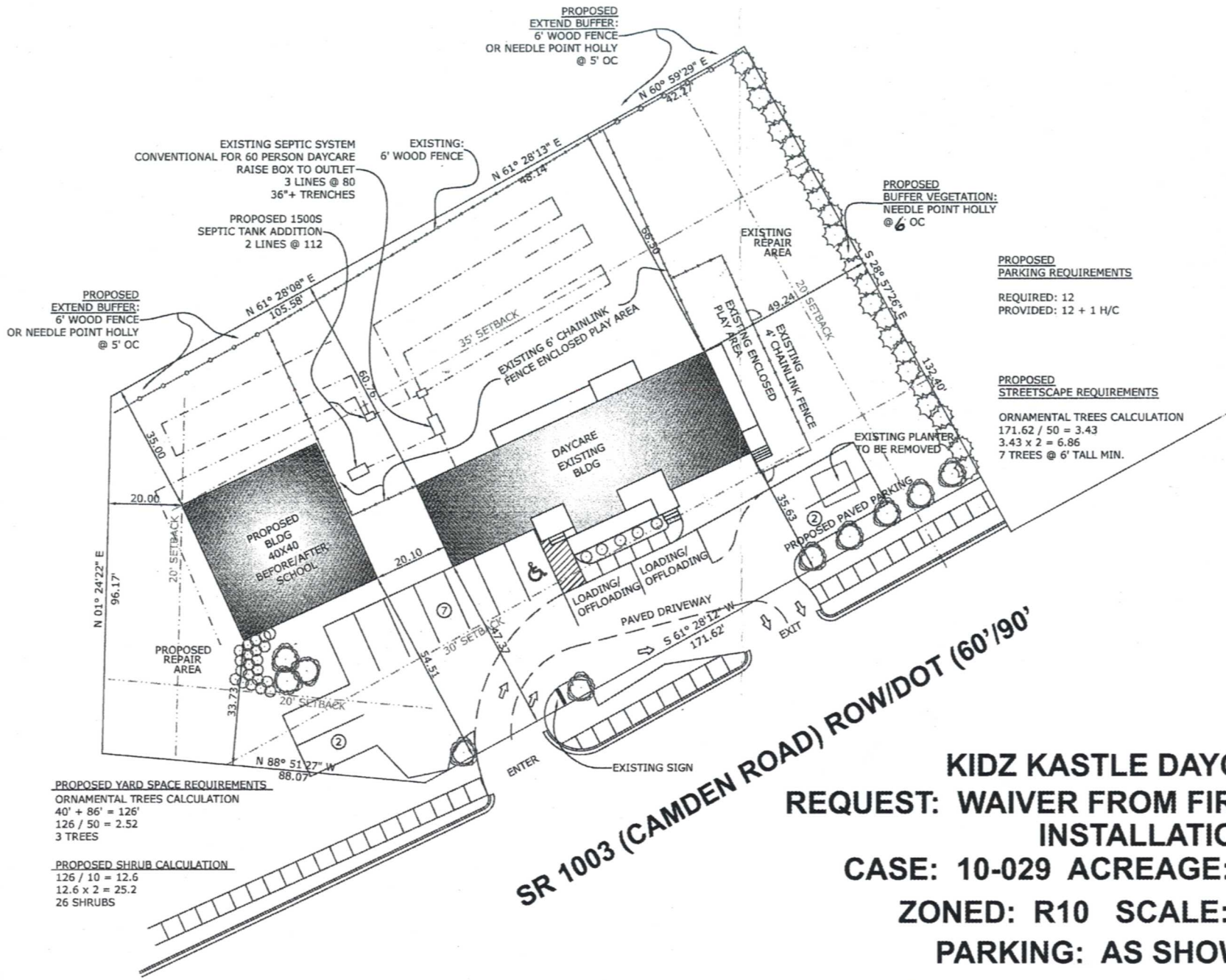

**SR 1003 (CAMDEN ROAD) ROW/DOT (60'/90')**

**KIDZ KASTLE DAYCARE  
 REQUEST: WAIVER FROM FIRE HYDRANT  
 INSTALLATION  
 CASE: 10-029 ACREAGE: 0.63 AC +/-  
 ZONED: R10 SCALE: NTS  
 PARKING: AS SHOWN**

\*SCALED DETAILED SITE PLAN IN FILE AVAILABLE FOR REVIEW UPON REQUEST

**PROPOSED  
 EXTEND BUFFER:  
 6' WOOD FENCE  
 OR NEEDLE POINT HOLLY  
 @ 5' OC**

**EXISTING SEPTIC SYSTEM  
 CONVENTIONAL FOR 60 PERSON DAYCARE  
 RAISE BOX TO OUTLET  
 3 LINES @ 80  
 36'+ TRENCHES**

**PROPOSED 1500S  
 SEPTIC TANK ADDITION  
 2 LINES @ 112**

**PROPOSED  
 EXTEND BUFFER:  
 6' WOOD FENCE  
 OR NEEDLE POINT HOLLY  
 @ 5' OC**

**PROPOSED  
 BUFFER VEGETATION:  
 NEEDLE POINT HOLLY  
 @ 6' OC**

**PROPOSED  
 PARKING REQUIREMENTS**  
  
 REQUIRED: 12  
 PROVIDED: 12 + 1 H/C

**PROPOSED  
 STREETSCAPE REQUIREMENTS**  
  
 ORNAMENTAL TREES CALCULATION  
 $171.62 / 50 = 3.43$   
 $3.43 \times 2 = 6.86$   
 7 TREES @ 6' TALL MIN.

**PROPOSED YARD SPACE REQUIREMENTS**  
 ORNAMENTAL TREES CALCULATION  
 $40' + 86' = 126'$   
 $126 / 50 = 2.52$   
 3 TREES

**PROPOSED SHRUB CALCULATION**  
 $126 / 10 = 12.6$   
 $12.6 \times 2 = 25.2$   
 26 SHRUBS

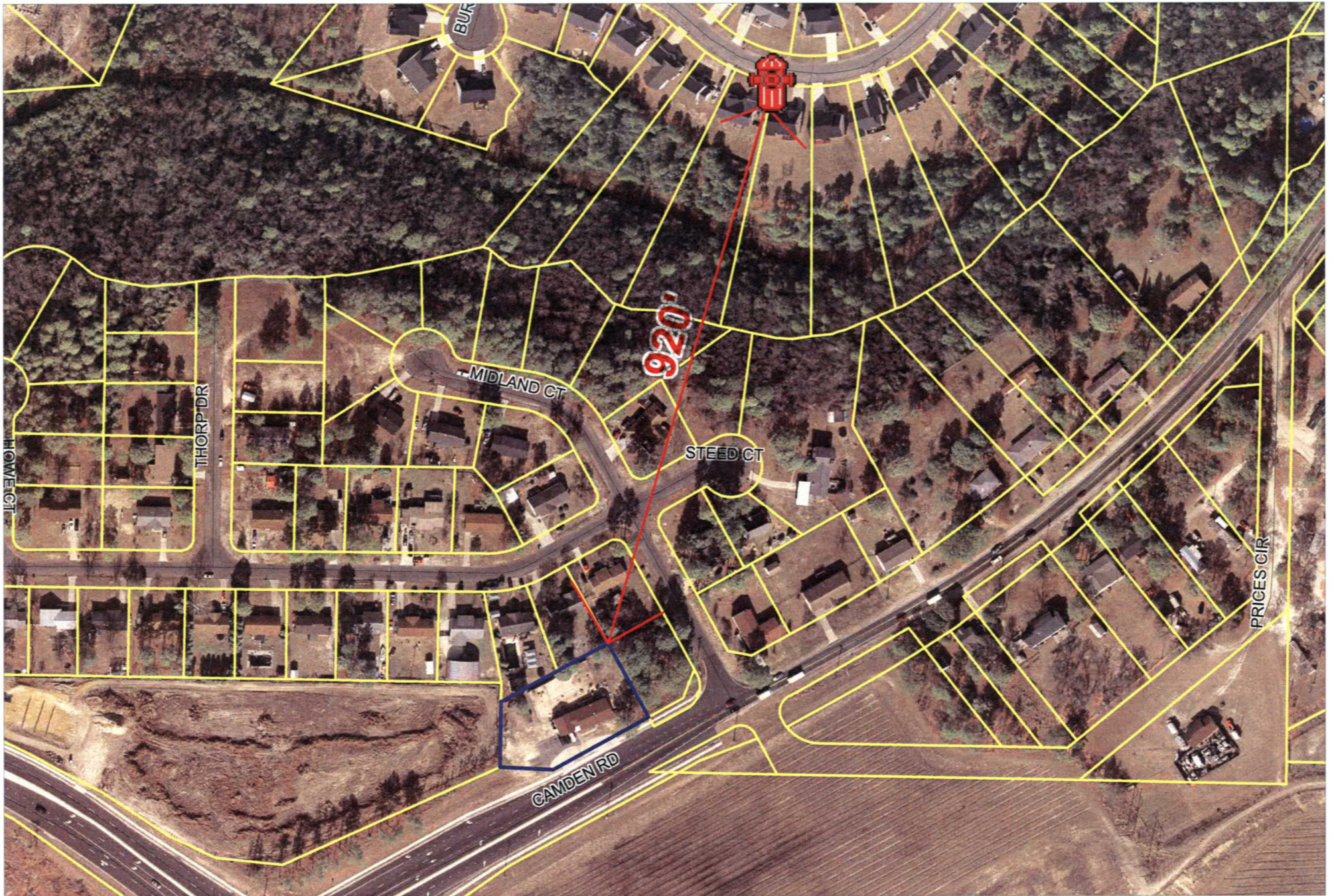

**AERIAL PHOTO & FIRE HYDRANT LOCATION**  
**CASE NO: 10-029**



File

**Members:**  
George Quigley, Chair  
John R. Swanson, Vice-Chair  
Oscar L. Davis, III  
Melree Hubbard Tart  
Joseph M. Dykes

**Alternates:**  
Martin J. Locklear  
Horace Humphrey  
Carrie Tyson-Autry  
William L. Tally  
Randy Newsome

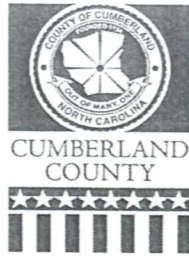

**CUMBERLAND COUNTY BOARD OF ADJUSTMENT**

130 Gillespie Street  
Fayetteville, NC 28301  
(910) 678-7602

**CERTIFIED MAIL**

October 28, 2009

91 7108 2133 3935 9755 9697

William and Angela Wright  
4820 Camden Road  
Fayetteville, NC 28306

**SUBJECT: P09-08-C:** CONSIDERATION OF A REQUEST FOR THE MODIFICATION OF AN APPROVED SPECIAL USE PERMIT (NÉE SPECIFIED CONDITIONAL USE) FOR A DAY CARE FACILITY IN A R10 RESIDENTIAL DISTRICT ON 0.63+/- ACRES, LOCATED AT 4820 CAMDEN ROAD, SUBMITTED AND OWNED BY WILLIAM AND ANGELA WRIGHT.

Dear Mr. and Mrs. Wright,

This is to inform you that the Cumberland County Board of Adjustment met on October 15, 2009 and after holding a public hearing on the above referenced case, the board voted unanimously to approve your application subject to the contents of the application, site plan and the following conditions:

**Pre-Permit Related:**

1. A recombination plat (also known as a "No Approval Required" or "NAR") recombining the subject property and the lot identified by PIN: 0415-52-9130 must be submitted to Land Use Codes for review and approval for recording with the County Register of Deeds, and the plat must be recorded prior to any permit application for any structure and/or prior to the sale of any lot or unit within this development. [Note: The previously platted lots (Lots 5 & 6, Plat Bk. 42, pg. 70) have been changed by deed only and a plat must be recorded reflecting current configuration of these lots prior to issuance of any permits.]

**Permit-Related:**

2. The owner/developer(s) of these lots must obtain detailed instructions on provisions of the County Zoning Ordinance and permits required to place any structure within this development from the County Code Enforcement Section, Room 101 in the Historic Courthouse at 130 Gillespie Street. For additional information, the developer should contact a Code Enforcement Officer.



3. The County Health Department must approve sewer plans prior to application for any permits. Site and soil evaluations must be conducted on the property by the County Environmental Health Department prior to application for permits. A copy of the Health Department approval must be provided to Code Enforcement at the time of application for any building/zoning permits. (Note: All Health Department requirements must be met prior to issuance of final permits.) (Section 2306 A, Water and Sewer, County Subdivision Ordinance)
4. Connection to public (community) water is required, the Aqua Water Company must approve water plans for the new construction prior to application for any permits. A copy of the Aqua Water Company's approval must be provided to Code Enforcement at the time of application for building/zoning permits. (Section 2306 A.1, Public Water and Sewer Systems County Subdivision Ordinance)
5. New development where the developer will disturb or intends to disturb more than one acre of land is subject to the Post-Construction Stormwater Management Permitting Program (Phase II Stormwater Management Requirements) administered by the Division of Water Quality, North Carolina Department of Environment and Natural Resources. If one acre or more of land is to be disturbed, prior to the issuance of any building/zoning permits for this site, a copy of the State's *Post-Construction Permit* must be provided to County Code Enforcement.
6. For any new development where the developer disturbs or intends to disturb more than one acre of land, the developer must provide the Code Enforcement Section with an approved NC Department of Environment and Natural Resources (NCDENR) sedimentation and erosion control plan (S&E) prior to any application for permits. (Note: If any retention/detention basins are required for state approval of this plan, then three copies of a revised plan must be submitted and approved by Planning & Inspections prior to application for any building/zoning permits.) A copy of the NCDENR approval must be provided to Code Enforcement at the time of application for any building/zoning permits.
7. The developer must provide a site-specific address and tax parcel number at the time of building/zoning permit application.
8. Landscaping must be provided in accordance with Section 1102 N, Landscaping, County Zoning Ordinance and/as shown on the site plan. The following are the minimum standards for the required landscaping of this site:
  - a. Three large shade trees or seven small ornamental trees within the front yard setback area; and
  - b. One small ornamental tree and eight shrubs are required in the building yard area.

In addition:

- a. Required plant materials shall be maintained by the property owner, including replacing dead or unhealthy trees and shrubs; and
- b. All yard and planting areas shall be maintained in a neat, orderly, and presentable manner and kept free of weeds and debris.

9. This conditional approval is not approval of the location of the freestanding sign. The developer must provide proof to Code Enforcement that the existing freestanding sign was properly permitted and in place at the current location prior to the widening of the right-of-way of SR 1003 (Camden Road). If the sign was not properly permitted, the existing sign must be relocated so that the setback standards of the ordinance are met and five copies of a revised site plan indicating proper sign location must be submitted for staff review and approval prior to application for the final building inspection. Attached signage for this development must be in accordance with the applicable sign regulations as set forth in Article XIII of the County Zoning Ordinance and that the proper permit(s) must be obtained prior to the installation of any permanent signs on the property. (Note: This conditional approval is **not** approval of the size, shape, or location of any signs.)
10. The building final inspection cannot be accomplished until a Code Enforcement Officer inspects the site and certifies that the site is developed in accordance with the approved plans.

**Site-Related:**

11. All uses, dimensions, setbacks and other related provisions of the County Subdivision and Zoning Ordinances for the R7.5 zoning district must be complied with, as applicable.
12. For any new development, an adequate drainage system must be installed by the developer in accordance with the NC Department of Environment and Natural Resources' (NCDENR) *Manual on Best Management Practices* and all drainage ways must be kept clean and free of debris. (Section 2306 D, County Subdivision Ordinance)
13. For new development, all utilities, except for 25kv or greater electrical lines, must be located underground. (Section 2306 C, County Subdivision Ordinance)
14. If driveways are changed or added, the developer must obtain a driveway permit from the NC Department of Transportation (NCDOT). If required, a copy of the approved driveway permit must be provided to Code Enforcement at the time of application for building/zoning permits.
15. Turn lanes may be required by the NC Department of Transportation (NCDOT).
16. All lighting is required to be directed internally within this development and comply with the provisions of Section 1102 M, Outdoor Lighting, County Zoning Ordinance.
17. A solid buffer must be provided and maintained along the side and rear property lines where this tract/site abuts residentially zoned properties in accordance with the provisions of Section 1102 G, Buffer Requirements, County Zoning Ordinance. (Note: Chain link fencing cannot be used to satisfy the buffer requirement.)
18. All dumpster, garbage, and utility areas shall be located on concrete pads and screened on a minimum of three sides.
19. All required off-street parking spaces shall be a minimum of 9' x 20'; a minimum of two spaces plus one space for each employee off-street parking spaces are required for the day care facilities.
20. A minimum of two off-street loading unloading spaces(s) with sufficient paved areas for access shall be provided.

21. All notes and calculations as shown on the site plan are to be considered as a part of this conditional approval.
22. Noise levels shall not exceed 60 dB(A) between the hours of 10:00 pm and 7:00 am. In any event, the noise level, regardless of the time of day, shall not become a nuisance to neighboring properties and strict compliance with the County's Noise Ordinance is required.

**Plat-Related:**

23. Prior to submission for final plat approval a fire hydrant must be installed along SR 1003 (Camden Road); hydrants must be located no further than 1,000 feet apart and at a maximum of 500 feet from any lot. (Section 2306 B, Fire hydrants, County Subdivision Ordinance)
24. Both lots must be platted and drawn with solid property lines, lot identifiers, bearing & distances, and the acreage reflected on the recombination plat. (Note: The current NCDOT right-of-way must be shown as it currently has been changed.)
25. The remaining portion of the existing 20 foot utility easement as shown on Plat Bk. 42, Pg 79 must be reflected on the recombination plat.
26. "Camden Road" be labeled as "SR 1003 (Camden Road)" on the recombination plat.
27. Any/All easements must be reflected on the recombination plat and labeled as to type of easement, reference number for document creating the easement, and the name of the agency, individual, etc. who holds the easement.
28. The notarized signature(s) of all current tax record owner(s) and notary certifications appear on the NAR recombination plat when submitted for final approval. (Section 2503 D, Certificate of Ownership and Dedication, County Subdivision Ordinance)
29. The developer is reminded that the improvements must be in place or that final plat approval will only be granted in accordance with Section 2502 B, C, or D, Final Plat – Guarantees of Improvements, Subdivision Ordinance. (Note: Once the improvements are in place, the developer is responsible for contacting Jeff Barnhill to schedule an inspection of the improvements.)

**Plat-Required Statements:**

30. Since this development does not have public sewer, the following disclosure statement is required to be provided on the recombination plat (Section 2504 C, On-Site Water and/or Sewer Discloser, County Subdivision Ordinance):

"The individual lots in this development do not have public sewer services available, and no lots have been approved by the Health Department for on-site sewer services at the date of this recording."

31. All structures shall be shown on the recombination plat or the recombination plat shall reflect the following statement (Section 2504 D, County Subdivision Ordinance):

"Nonconforming structures have not been created by this recombination."

**Advisories:**

32. The applicant is advised to consult an expert on wetlands before proceeding with any development.
33. The owner/developer is responsible for ensuring easements which may exist on the subject property are accounted for, not encumbered and that no part of this development is violating the rights of the easement holder.

**Other Relevant Conditions:**

34. The owner/developer be aware that every deed created for a lot being served by an on-site water and/or sewer system must contain the following disclosure when filed with the County Register of Deeds:

"Public sewer services are not available as of the date of the recording of this deed. On-site sewer disposal systems must be approved by the County Health Department."

**If you need clarification of any conditions, please contact Ed Byrne at 910-678-7609 or Patti Speicher at 910-678-7605; otherwise, contact the appropriate agency at the contact number(s) below.**

If you have any questions, please contact Pier Varner at (910) 678-7602, email: [pvarner@co.cumberland.nc.us](mailto:pvarner@co.cumberland.nc.us).

Sincerely,

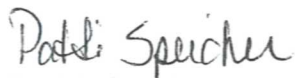

Patricia Speicher  
Land Use Codes

Attachments: 1 – Sketch Map  
2 – Site Plan  
3 – Application

cc: Ken Sykes, Code Enforcement Coordinator  
Mike Bailey, Town of Hope Mills  
File

Contact Information (Area Code is 910 unless otherwise stated):

Improvements Inspections:	Jeff Barnhill	678-7765
Subdivision/Site Plan/Plat:	Ed Byrne	678-7609
Code Enforcement (Permits):	Ken Sykes	321-6654
County Health Department:	Danny Soles	433-3685
Aqua Water Company:	Sharon McDaniel	467-7854
Corp of Engineers (wetlands):	Ronnie Smith	251-4829
NCDENR (E&S):	Sally McKinney	433-3300
E911 Site-Specific Address:	Ron Gonzales	678-7616
Tax Parcel Numbers:		678-7549
NCDOT (driveways/curb-cuts):	Gary Burton	486-1496
N.C. Division of Water Quality:	Mike Randall	(919) 733-5083 ext. 545

**TO THE CUMBERLAND COUNTY JOINT PLANNING BOARD,  
FAYETTEVILLE, NORTH CAROLINA:**

I (We), the undersigned, hereby submit this application, and petition the Cumberland County Joint Planning Board to waive [vary] certain adopted provisions of the County's Subdivision Ordinance as specified below and provided for under the terms of the Subdivision Ordinance. In support of this petition, the following facts are submitted:

LOCATION OF PROPERTY: 4820 Camden Rd  
OWNER: William & Angela Wright  
ADDRESS: 2805 Meadowmont Ln ZIP CODE: 28306  
TELEPHONE: HOME (910) 423-7701 WORK (910) 322-4953  
AGENT: \_\_\_\_\_  
ADDRESS: \_\_\_\_\_  
TELEPHONE: HOME \_\_\_\_\_ WORK \_\_\_\_\_

**APPLICATION FOR A WAIVER [VARIANCE]  
As required by the Subdivision Ordinance**

- A. Parcel Identification Number (PIN #) of subject property: 0415-52-7093  
(also known as Tax ID Number or Property Tax ID)
- B. Acreage: .63 Frontage: 171 ft Depth: 132 ft
- C. Water Provider: AQUA WATER
- D. Septage Provider: Septic
- E. Deed Book 5332 PG, Page(s) 0683, Cumberland County Registry. (Attach copy of deed of subject property as it appears in Registry).
- F. Existing and/or proposed use of property: Day Care

G. Section and provision of the Cumberland County Subdivision Ordinance from which a waiver [variance] is requested:  
2306.B. Not to want to have to install fire hydrant

H. Nature and extent of hardship involved in strict application of the County Subdivision Ordinance – attach additional sheet if necessary:

The AQUA water company that I currently have at this property does not provide fire flow since it has a hydro-pneumatic tank for water storage and PWC does not currently provide water and sewer to location. See attachment letters →





Aqua North Carolina, Inc.  
5948 Fisher Road  
Suite 101  
Fayetteville, NC 28304  
An Aqua America Company

*Copy*

*Mailed to  
Angela Wright  
4820 Camden Rd  
on Day Care  
KIDZ KASTLE*

November 16, 2009

Re: Copeland Acres Subdivision  
PWS # 03-26-143

To Whom It May Concern:

Copeland Acres subdivision is served by an approved water system owned and operated by Aqua North Carolina. This water system does not provide fire flow since it has a hydropneumatic tank for water storage, therefore no fire hydrants are allowed on this water distribution system in accordance with Sec. .0901 of, "Rules Governing Public Water Systems".

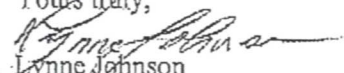
Yours truly,  
  
Lynne Johnson  
Field Supervisor





WILSON A. LACY, COMMISSIONER  
 TERRI UNION, COMMISSIONER  
 LUIS J. OLIVERA, COMMISSIONER  
 MICHAEL G. LALLIER, COMMISSIONER  
 STEVEN K. BLANCHARD, CEO/GENERAL MANAGER

**PUBLIC WORKS COMMISSION**  
 OF THE CITY OF FAYETTEVILLE  
 ELECTRIC & WATER UTILITIES

955 OLD WILMINGTON RD  
 P.O. BOX 1089  
 FAYETTEVILLE, NORTH CAROLINA 28302-1089  
 TELEPHONE (AREA CODE 910) 483-1401  
 FAX (AREA CODE 910) 829-0207

February 23, 2010

**TO WHOM IT MAY CONCERN:**

**SUBJECT: 4820 Camden Rd. Fayetteville, NC 28306 PIN# 0415-52-7093-**

**WATER AND SEWER UTILITIES**

This letter is to verify that the Public Works Commission does not currently provide, own or maintain water and sewer utilities to subject location, and consequently cannot supply a fire hydrant for this project.

Signed,  
**PUBLIC WORKS COMMISSION**

John Allen, PE  
 Senior Engineer  
 Water Resources Engineering Department

Post-it® Fax Note	7671	Date	2/23	# of pages	1
To	Jason	From	Liz Vasser		
Co./Dept	Regency Const	Co.	PWC		
Phone #	824-4006	Phone #	223-4730		
Fax #	826-9022	Fax #	829-0203		