

Patricia Hall,  
Chair  
Town of Hope Mills

Charles Morris,  
Vice-Chair  
Town of Linden

Garland C. Hostetter,  
Town of Spring Lake  
Harvey Cain, Jr.,  
Town of Stedman

Donovan McLaurin,  
Wade, Falcon & Godwin



**CUMBERLAND**  
★ **COUNTY** ★  
NORTH CAROLINA

*Planning & Inspections Department*

Thomas J. Lloyd,  
Director

Cecil P. Combs,  
Deputy Director

Vikki Andrews,  
Diane Wheatley,  
Carl Manning,  
Walter Clark  
Cumberland County

Benny Pearce,  
Town of Eastover

**TENTATIVE AGENDA**

August 19, 2014

7:00 P.M.

- I. INVOCATION AND PLEDGE OF ALLEGIANCE
- II. APPROVAL OF/ADJUSTMENTS TO AGENDA
- III. PUBLIC HEARING DEFERRAL/WITHDRAWAL
- IV. ABSTENTIONS BY BOARD MEMBERS
- V. POLICY STATEMENT REGARDING PUBLIC HEARING TIME LIMITS
- VI. APPROVAL OF THE MINUTES OF JULY 15, 2014
- VII. PUBLIC HEARING ITEM

**TEXT AMENDMENT**

- A. **P14-43.** REVISIONS AND AMENDMENTS TO THE TOWN OF SPRING LAKE CODE OF ORDINANCES, CHAPTER 42 ZONING BY ADOPTING AND ESTABLISHMENT OF A MAIN STREET OVERLAY DISTRICT (MSOD) AMENDING THE TOWN'S ZONING MAP, CREATING THE OVERLAY DISTRICT LAYER ON 77.44+/- ACRES GENERALLY FOLLOWING ALONG BOTH SIDES OF NORTH AND SOUTH MAIN STREETS; AND AMENDING ARTICLE I. DEFINITIONS, SECTION 42-8. DEFINITIONS, BY INSERTING IN ALPHABETICAL ORDER THE TERMS AND DEFINITIONS FOR *AMPHITHEATRE*, *BARS & NIGHTCLUBS*, AND *RESTAURANT*; AMENDING ARTICLE II. ZONING DISTRICTS, SECTION 42-35. STATEMENT OF DISTRICT INTENT; PURPOSE AND ZONE CHARACTERISTICS, SUB-SECTION (7) CB CENTRAL BUSINESS DISTRICT, AND CREATING A NEW SUB-SECTION (17), ENTITLED *MAIN STREET OVERLAY DISTRICT (MSOD)*; AMENDING ARTICLE III. PERMITTED PRINCIPAL USES AND STRUCTURES, SECTION 42-63. DISTRICT USE REGULATIONS, TABLE OF USES; AMENDING ARTICLE VII. PLANNED DISTRICTS, SECTION 42-168. SPECIFICATIONS FOR CERTAIN PLANNED DISTRICTS, AND CREATING A NEW SECTION 42-174, ENTITLED *SPECIFICATIONS FOR THE CB CENTRAL BUSINESS DISTRICT*; AMENDING ARTICLE XI. SIGN REGULATIONS, SECTION 42-293. SIGNS PERMITTED BY DISTRICTS; AND AMENDING ARTICLE XIII. ADMINISTRATION AND ENFORCEMENT, SECTION 42-359. ZONING PERMIT REQUIRED; APPROVAL OF PLANS; ISSUANCE, BY CREATING A NEW SUB-SECTION (D); AND UPDATING THE TABLE OF CONTENTS AS APPROPRIATE.

VIII. PUBLIC HEARING CONSENT ITEMS

REZONING CASES

- B. **P14-40.** REZONING OF 3.34+/- ACRES FROM R10 RESIDENTIAL TO O&I(P) PLANNED OFFICE AND INSTITUTIONAL OR TO A MORE RESTRICTIVE ZONING DISTRICT, LOCATED AT 4231 AND 4239 CAMERON ROAD, SUBMITTED BY TIMOTHY EVANS (OWNER).
- C. **P14-41.** REZONING OF .68+/- ACRE FROM C1(P) PLANNED LOCAL BUSINESS TO RR RURAL RESIDENTIAL OR TO A MORE RESTRICTIVE ZONING DISTRICT; LOCATED ON THE NORTHEAST SIDE OF NC HWY 87 (N BRAGG BLVD), NORTH OF MARANATHA CIRCLE; SUBMITTED BY MARY ANN TEW (OWNER) AND RICHARD DANIELS.
- D. **P14-42.** REZONING OF 1.72+/- ACRES FROM RR RURAL RESIDENTIAL/CZ CONDITIONAL ZONING FOR A SWEEPSTAKES/INTERNET CAFÉ TO A1 AGRICULTURAL OR TO A MORE RESTRICTIVE ZONING DISTRICT, LOCATED AT 3451 CHICKEN FOOT ROAD, SUBMITTED BY MANLY ALAN AND JUDY S. BOYKIN (OWNERS).

IX. PUBLIC HEARING CONTESTED ITEMS

MODIFICATION OF CONDITIONAL ZONING

- E. **P13-45.** MODIFICATION OF A CONDITION FOR AN APPROVED A1 AGRICULTURAL/CZ CONDITIONAL ZONING FOR AN OUTDOOR FIRING RANGE AND AGRICULTURAL USES CONSISTING OF 978.40 +/- ACRES, ALLOWING FOR HOURS OF OPERATION NOT APPLY TO LAW ENFORCEMENT QUALIFICATION AND TRAINING; LOCATED AT 2850 TIGERSWAN DRIVE; SUBMITTED BY D. STEWART PRECYTHE ON BEHALF OF PRECYTHE PROPERTIES, LLC. (OWNER) AND STEVEN M. SWIERKOWSKI ON BEHALF OF THE RANGE COMPLEX.

X. DISCUSSION

DIRECTOR'S UPDATE

XI. ADJOURNMENT



Patricia Hall,  
Chair  
Town of Hope Mills

Charles C. Morris,  
Vice-Chair  
Town of Linden

Garland C. Hostetter,  
Town of Spring Lake  
Harvey Cain, Jr.,  
Town of Stedman

Donovan McLaurin  
Wade, Falcon & Godwin



**CUMBERLAND**  
★ **COUNTY** ★  
NORTH CAROLINA

*Planning & Inspections Department*

August 12, 2014

Thomas J. Lloyd,  
Director

Cecil P. Combs,  
Deputy Director

Vikki Andrews,  
Diane Wheatley,  
Carl Manning,  
Walter Clark,  
Cumberland County

Benny Pearce,  
Town of Eastover

**MEMORANDUM**

**TO:** Cumberland County Joint Planning Board

**FROM:** Planning and Inspections Staff

**SUBJECT:** Staff Recommendation for the August 19, 2014 Board Meeting

**P14-43.** REVISIONS AND AMENDMENTS TO THE TOWN OF SPRING LAKE CODE OF ORDINANCES, CHAPTER 42 ZONING BY ADOPTING AND ESTABLISHMENT OF A MAIN STREET OVERLAY DISTRICT (MSOD) AMENDING THE TOWN'S ZONING MAP, CREATING THE OVERLAY DISTRICT LAYER ON 77.44+/- ACRES GENERALLY FOLLOWING ALONG BOTH SIDES OF NORTH AND SOUTH MAIN STREETS; AND AMENDING ARTICLE I. DEFINITIONS, SECTION 42-8. DEFINITIONS, BY INSERTING IN ALPHABETICAL ORDER THE TERMS AND DEFINITIONS FOR *AMPHITHEATRE*, *BARS & NIGHTCLUBS*, AND *RESTAURANT*; AMENDING ARTICLE II. ZONING DISTRICTS, SECTION 42-35. STATEMENT OF DISTRICT INTENT; PURPOSE AND ZONE CHARACTERISTICS, SUB-SECTION (7) CB CENTRAL BUSINESS DISTRICT, AND CREATING A NEW SUB-SECTION (17), ENTITLED *MAIN STREET OVERLAY DISTRICT (MSOD)*; AMENDING ARTICLE III. PERMITTED PRINCIPAL USES AND STRUCTURES, SECTION 42-63. DISTRICT USE REGULATIONS, TABLE OF USES; AMENDING ARTICLE VII. PLANNED DISTRICTS, SECTION 42-168. SPECIFICATIONS FOR CERTAIN PLANNED DISTRICTS, AND CREATING A NEW SECTION 42-174, ENTITLED *SPECIFICATIONS FOR THE CB CENTRAL BUSINESS DISTRICT*; AMENDING ARTICLE XI. SIGN REGULATIONS, SECTION 42-293. SIGNS PERMITTED BY DISTRICTS; AND AMENDING ARTICLE XIII. ADMINISTRATION AND ENFORCEMENT, SECTION 42-359. ZONING PERMIT REQUIRED; APPROVAL OF PLANS; ISSUANCE, BY CREATING A NEW SUB-SECTION (D); AND UPDATING THE TABLE OF CONTENTS AS APPROPRIATE. (SPRING LAKE)

**1<sup>ST</sup> MOTION**

The Planning and Inspections Staff recommends approval Case No. P14-43 for a text and map amendment creating a Main Street Overlay District for the Town of Spring Lake because the proposed ordinance provisions for the overlay district are designed to encourage new construction and re-development in an area that is oriented towards serving the citizens of Spring Lake and the traveling public, in addition to increasing the economic well-being of the town.

**2<sup>nd</sup> MOTION**

The Planning and Inspections recommends the board find that approval of the map and text amendment in Case No. P14-43 is consistent with the adopted comprehensive plan designated as the *2030 Growth Vision Plan* because the Growth Vision Map classifies the subject properties as being in an “Urban” area and the language in the proposed text is an effort to ensure that *better, more quality-conscious development standards are applied consistently throughout the county, resulting in higher quality developments* (Vision Statement from 2030 Growth Vision Plan). The provisions contained in the proposed amendment are supported by many policies and actions of the 2030 Plan to include Policy Areas: 1, A More Diversified Local Economy; 2, Well-Managed Growth and Development; Infrastructure That Keeps Pace; 9, Compatible Commercial Development; 10, Community Appearance and Image and 11, A Healthy, Sustainable Environment. The request is also consistent with the Spring Lake Area Detailed Land Use Plan which recommends a *downtown plan* for the area in which the subject properties are located.

The staff further recommends the board find that approval of the map and text amendment is reasonable and in the public interest because the proposal promotes the protection and enhancement of the downtown Main Street area by facilitating the efficient and adequate provisions for infrastructure particularly motor vehicle parking and pedestrian walkways, and maintaining and stimulating a pedestrian-friendly, vibrant environment while encouraging economic growth that compliments and expands the unique character of the downtown area .

Attachments:

- 1 – Site Profile
- 2 – Sketch Map
- 3 – P14-43 Main Street Overlay District



**P14-43**  
**SITE PROFILE**

**P14-43.** REVISIONS AND AMENDMENTS TO THE TOWN OF SPRING LAKE CODE OF ORDINANCES, CHAPTER 42 ZONING BY ADOPTING AND ESTABLISHMENT OF A MAIN STREET OVERLAY DISTRICT (MSOD) AMENDING THE TOWN'S ZONING MAP, CREATING THE OVERLAY DISTRICT LAYER ON 77.44+/- ACRES GENERALLY FOLLOWING ALONG BOTH SIDES OF NORTH AND SOUTH MAIN STREETS; AND AMENDING ARTICLE I. DEFINITIONS, SECTION 42-8. DEFINITIONS, BY INSERTING IN ALPHABETICAL ORDER THE TERMS AND DEFINITIONS FOR *AMPHITHEATRE*, *BARS & NIGHTCLUBS*, AND *RESTAURANT*; AMENDING ARTICLE II. ZONING DISTRICTS, SECTION 42-35. STATEMENT OF DISTRICT INTENT; PURPOSE AND ZONE CHARACTERISTICS, SUB-SECTION (7) CB CENTRAL BUSINESS DISTRICT, AND CREATING A NEW SUB-SECTION (17), ENTITLED *MAIN STREET OVERLAY DISTRICT (MSOD)*; AMENDING ARTICLE III. PERMITTED PRINCIPAL USES AND STRUCTURES, SECTION 42-63. DISTRICT USE REGULATIONS, TABLE OF USES; AMENDING ARTICLE VII. PLANNED DISTRICTS, SECTION 42-168. SPECIFICATIONS FOR CERTAIN PLANNED DISTRICTS, AND CREATING A NEW SECTION 42-174, ENTITLED *SPECIFICATIONS FOR THE CB CENTRAL BUSINESS DISTRICT*; AMENDING ARTICLE XI. SIGN REGULATIONS, SECTION 42-293. SIGNS PERMITTED BY DISTRICTS; AND AMENDING ARTICLE XIII. ADMINISTRATION AND ENFORCEMENT, SECTION 42-359. ZONING PERMIT REQUIRED; APPROVAL OF PLANS; ISSUANCE, BY CREATING A NEW SUB-SECTION (D); AND UPDATING THE TABLE OF CONTENTS AS APPROPRIATE. (SPRING LAKE)

**Main Street Overlay District:**

**Frontage & Location:** 5,650.00'+/- along SR 1448 (Main Street)

**Depth:** 1,460.00'+/-

**Jurisdiction:** Spring Lake

**Initial Zoning:** May 28, 1979 (Town of Spring Lake) – General zoning references only, some individual lots have since been rezoned

**Surrounding Land Use:** Mix of industrial, commercial, residential & woodlands

**2030 Growth Vision Plan:** Urban Area

**Spring Lake Area Detailed Land Use Plan:** Downtown, planned commercial, office & institutional & residential

**Water/Sewer Availability:** Spring Lake/Spring Lake

**Soil Limitations:** None

**Average Daily Traffic Count (2010):** 3,100 on SR 1449 (Main Street)

**Note:**

**Proposed map and text is attached**

**First Class and Record Owners' Mailed Notice Certification**

*A certified copy of the tax record owner(s) of the subject and adjacent properties and their tax record mailing address is contained within the case file and is incorporated by reference as if delivered herewith.*



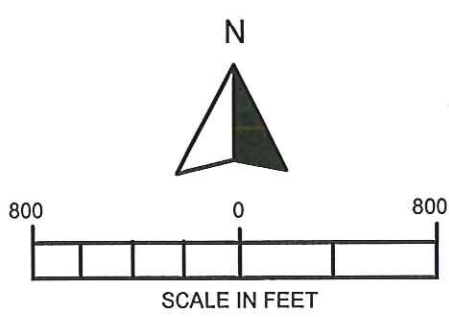
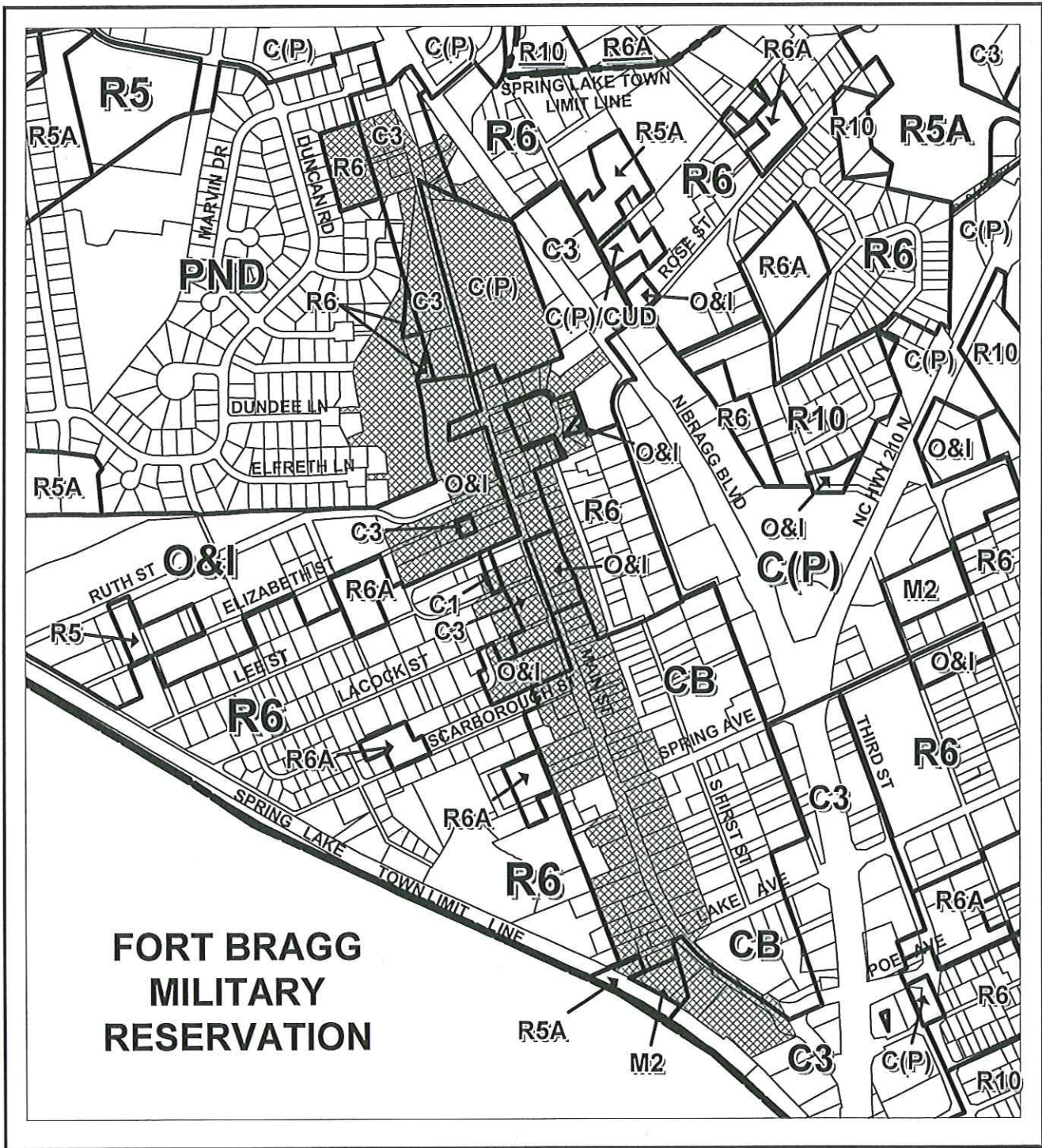

PIN: SEE FILE

## MAIN STREET OVERLAY DISTRICT REZONING

ACREAGE: 77.44 AC. +/-	HEARING NO: P14-43	
ORDINANCE: SPRING LAKE	HEARING DATE	ACTION
STAFF RECOMMENDATION		
PLANNING BOARD		
GOVERNING BOARD		



**P14-43**  
**Town of Spring Lake**  
**Zoning Chapter Text and Map Amendment**  
**Main Street Overlay District (MSOD)**

REVISIONS AND AMENDMENTS TO THE TOWN OF SPRING LAKE CODE OF ORDINANCES, CHAPTER 42 ZONING BY ADOPTING AND ESTABLISHMENT OF A MAIN STREET OVERLAY DISTRICT (MSOD) AMENDING THE TOWN'S ZONING MAP, CREATING THE OVERLAY DISTRICT LAYER ON 77.44+/- ACRES GENERALLY FOLLOWING ALONG BOTH SIDES OF NORTH AND SOUTH MAIN STREETS; AND AMENDING ARTICLE I. DEFINITIONS, SECTION 42-8. DEFINITIONS, BY INSERTING IN ALPHABETICAL ORDER THE TERMS AND DEFINITIONS FOR *AMPHITHEATRE*, *BARS & NIGHTCLUBS*, AND *RESTAURANT*; AMENDING ARTICLE II. ZONING DISTRICTS, SECTION 42-35. STATEMENT OF DISTRICT INTENT; PURPOSE AND ZONE CHARACTERISTICS, SUB-SECTION (7) CB CENTRAL BUSINESS DISTRICT, AND CREATING A NEW SUB-SECTION (17), ENTITLED *MAIN STREET OVERLAY DISTRICT (MSOD)*; AMENDING ARTICLE III. PERMITTED PRINCIPAL USES AND STRUCTURES, SECTION 42-63. DISTRICT USE REGULATIONS, TABLE OF USES; AMENDING ARTICLE VII. PLANNED DISTRICTS, SECTION 42-168. SPECIFICATIONS FOR CERTAIN PLANNED DISTRICTS, AND CREATING A NEW SECTION 42-174, ENTITLED *SPECIFICATIONS FOR THE CB CENTRAL BUSINESS DISTRICT*; AMENDING ARTICLE XI. SIGN REGULATIONS, SECTION 42-293. SIGNS PERMITTED BY DISTRICTS; AND AMENDING ARTICLE XIII. ADMINISTRATION AND ENFORCEMENT, SECTION 42-359. ZONING PERMIT REQUIRED; APPROVAL OF PLANS; ISSUANCE, BY CREATING A NEW SUB-SECTION (D); AND UPDATING THE TABLE OF CONTENTS AS APPROPRIATE. (SPRING LAKE)

Chapter 42

**ZONING\***

**AMEND ARTICLE I. IN GENERAL, Sec. 42-8. Definitions, by INSERTING the following terms and definitions in alphabetical order:**

**ARTICLE I. IN GENERAL**

**Sec. 42-8. Definitions.**

*Amphitheatre means a freestanding, open-air round or oval structure with a central arena and tiers of concentric seats.*

Bars & nightclubs means establishments including private clubs, sports bars/clubs etc., that may be licensed to sell alcoholic beverages to be consumed on the premises and do not meet the criteria to be a restaurant, and does not include any use that qualifies to be regulated under Section 42-91.

Restaurant means an eating establishment, including cafeterias, cafes, grills, or fast-food establishments that have a gross receipts from food sales and non-alcoholic beverage sales of at least 30 percent of the total gross receipts including alcoholic beverage sales. This definition does not include any use that qualifies to be regulated under Section 42-91.

**AMEND ARTICLE II. ZONING DISTRICTS, Sec. 42-35. Statement of district intent; purpose and zone characteristics, as indicated below:**

## **ARTICLE II. ZONING DISTRICTS**

**Sec. 42-35. Statement of district intent; purpose and zone characteristics.**

- (7) *CB Central Business District.* This district is intended to preserve and enhance the original downtown area as a compact, viable and convenient location for a wide variety of commercial and office uses. Residential uses are permitted only in conjunction with a mixed use building or mixed use development, and shall be located to the rear or on the second floor or above of any structure. ~~Residential uses developed to R-5A standards are also permitted.~~ To preserve the compactness of the area and to lessen ~~lessen~~ congestion the display, sales and storage of goods is ~~predominantly~~ conducted entirely within enclosed buildings. The yard requirements are based generally on the pattern of existing development so as to minimize dimensional disparities ~~nonconformities~~ and to preserve the continued usefulness and essential character of the existing buildings located in the downtown area. In order to promote coordination and the compatible intermixture of residential and commercial development, this district is a planned district and site plan review is required for every development, re-development or change-in-use. ~~Residential and nonresidential uses on the same floor of any building is not permitted.~~

*[Note: Mixed use buildings and mixed use developments are currently allowed in the Spring Lake ordinance.]*

**AMEND ARTICLE II. ZONING DISTRICTS, Sec. 42-35. Statement of district intent; purpose and zone characteristics, by CREATING a new sub-section (17) as written below:**



(17) Main Street Overlay District (MSOD). An overlay district intended to protect and enhance the traditional downtown main street area by maintaining and stimulating a pedestrian-friendly, vibrant environment while encouraging economic growth that compliments and expands the unique character of the downtown area. Individual structures are encouraged to be multi-story with uses mixed vertically, street level commercial and upper level office and/or residential. It is the purpose of these regulations to encourage vitality by excluding certain activities which have a negative effect on the public realm through motor vehicle dominated or non-pedestrian oriented design or uses. To facilitate the purpose and intent of this overlay district, proposed uses and all development plans shall be consistent with the regulations as contained within this chapter for the CB Central Business district.

**AMEND ARTICLE III. PERMITTED PRINCIPAL USES AND STRUCTURES, Sec. 42-63.** District use regulations, **TABLE OF PERMITTED AND CONDITIONAL USES**, for those land uses and districts as related to uses to be allowed within the Main Street Overlay District (MSOD) and other inter-related required changes as indicated on the next page.

### **ARTICLE III. PERMITTED PRINCIPAL USES AND STRUCTURES**

**Sec. 42-63.** District use regulations.

[Editor's note: See *Table of Uses* starting next page.]

TABLE OF PERMITTED AND CONDITIONAL USES

<i>Permitted Uses</i>	<i>RR</i>	<i>R-15 R-10 R-6</i>	<i>R-5 R-5A</i>	<i>R-6A</i>	<i>O &amp; I</i>	<i>C-1</i>	<i>CB</i>	<i>HS(P)</i>	<i>C(P) C-3</i>	<i>M-1</i>	<i>M(P) M-2</i>
Alcohol sales							X <sup>2</sup>	X	X		
Amphitheatre							X		X		
Automobile washing							X		X		X
Automobile wrecking yards and junkyards									C		C
Baking on-premises and retail only						X	X		X		
Bakery production and wholesale sales									X	X	X
Bank, savings and loan company and other financial activities					X	X	X		X		
Bars & nightclubs							X		X		
Barber or beauty college instruction							X		X		
Barbering and hairdressing services							X				
Bicycle sales and repairing											
Bingo									X		
Blacksmith services	X										
Boarding house operations		C	C	C	C						
Boats and accessories, retail sales and service									X		
Bookbinding							X		X	X	X
Books and printed matter, distribution					X	X	X		X	X	X
Bottled gas distributing, bulk storage											X
Bottling										X	X
Builders' supply (no outside storage)								X		C	XX
Builders' supply (with outside storage)										X	X
Bus repair and storage terminal activities									X	X	X
Bus station activities							X		X		
Bus station activities, local service only							X				
Cabinet making										X	X
Candy or confectionary making, on premises and retail only						X	X		X	X	
Carpet and rug cleaning									X	X	X
Catalogue sales							X		X		
Cemetery	C	C	C	C							



TABLE OF PERMITTED AND CONDITIONAL USES

<i>Permitted Uses</i>	<i>RR</i>	<i>R-15 R-10 R-6</i>	<i>R-5 R-5A</i>	<i>R-6A</i>	<i>O &amp; I</i>	<i>C-1</i>	<i>CB</i>	<i>HS(P)</i>	<i>C(P) C-3</i>	<i>M-1</i>	<i>M(P) M-2</i>
Children's day care homes	C	C	C	C	C						
Children's day care centers					C	C	C		C		
Clinic services, medical and dental					X	X	X		X		
Club or lodge	C	C	C	C	X	X			X		
Coal sales and storage											X
Construction storage (outside)											X
Convalescent home	C	C	C	C	X						
Curio and souvenir sales							X	X	X		
Dairy products sales and processing										X	X
Dairy products sales on-premises, retail sales only						X	X		X		
Delicatessen operations (including catering)					X	X	X	X	X		
Dry cleaning, commercial										X	X
Dry cleaning and laundry collection (no cleaning on premises)						X	X		X		
Dwelling, multiple-family		X	X	X	S <sup>1</sup>	S <sup>1</sup>	S <sup>1</sup>		S <sup>1</sup>		
Dwelling, single-family	X	X	X	X	S <sup>1</sup>	S <sup>1</sup>	S <sup>1</sup>		S <sup>1</sup>		
<del>Eating or drinking facilities (drive-ins excluded)</del>							<del>X</del>	<del>X</del>	<del>X</del>		
<del>Eating or drinking facilities (drive-ins included)</del>								<del>X</del>	<del>X</del>		
Employee's service (not designed for or available to public customers)									X	X	X
Exterminating service									X	X	X
Fairground activities (including carnivals and circuses)	C									C	
Farm machinery sales and servicing									C	X	X
Farmer's market, open-air	C					C			C		
Farm supplies merchandise (excluding farm machinery)							X		X	X	X

ZONING

§ 42-63

TABLE OF PERMITTED AND CONDITIONAL USES

<i>Permitted Uses</i>	RR	R-15 R-10 R-6	R-5 R-5A	R-6A	O & I	C-1	CB	HS(P)	C(P) C-3	M-1	M(P) M-2
Fire station operations	C	C	C	C	X	X			X		X
Flower shop						X	X		X		
Food freezer operations									X	X	X
Food sales (<= 12,000 sq ft in area)						X	X		X		
Food sales (>12,000 sq ft in area)						X			X		
Funeral home					X				X		
Fur sales, including cold storage									X	X	
Greenhouse operations, commercial									X	X	X
Gunsmith									X		
Hardware, paint, and garden supply sales						X	X		X		
Hatchery operations											X
Home care unit	C	C	C	C							
Home for the aged	C	C	C	C	X						
Home furnishing and appliance sales							X		X		
Home occupation, incidental	X	X	X	X			X				
Hospital or sanitarium	C	C	C		X						
Ice manufacturing										X	X
Industrial operations not otherwise prohibited											X
Industrial sales of equipment or repair service											X
Industry, pilot operation										X	X
Janitorial service									X	X	
Laboratory operations, medical or dental					X		X		X		
Laboratory, research					X		X		X		
Laundering, commercial									X	X	
Laundering or dry cleaning customer self-service							X		X		
Library	X	X	X	X	X		X		X		
Livestock sales and auctioning	C										X
Locksmith, <del>gunsmith</del>							X		X		
Machine tool manufacturing or welding											X

§ 42-63

SPRING LAKE MUNICIPAL CODE



TABLE OF PERMITTED AND CONDITIONAL USES

<i>Permitted Uses</i>	<i>RR</i>	<i>R-15 R-10 R-6</i>	<i>R-5 R-5A</i>	<i>R-6A</i>	<i>O &amp; I</i>	<i>C-1</i>	<i>CB</i>	<i>HS(P)</i>	<i>C(P) C-3</i>	<i>M-1</i>	<i>M(P) M-2</i>
Manufactured home, Class A		X*									
Manufacturing (See Industries)											
Mobile home (individual) for exhibition	C	C	C	C	C	C	€	C	C	C	C
Mobile home park, but excluding any mobile home sales				X							
Mobile home sales but excluding any residential occupancy									X		
Monument sales									X	X	X
Monument works											X
Newspaper publishing									X	X	X
Newsstand sales					X	X	X	X	X		
Nursery operation (plants) retail and production	C									X	X
Nursing home	C	C	C	C	X						
Office supplies and equipment, sales and service							X		X		
Office use of a doctor, dentist, osteopath, chiropractor, optometrist, physiotherapist, or other medically oriented profession					X	X	X		X		
Office use, with no on-premises stock of goods for sale to the general public and the operations and service of which are customarily conducted and concluded by means of written, verbal or mechanically reproduced communications material					X	X	X		X		
Optician services					X		X		X		
Pawn shop and swap shop sales							X		X		X
Pet sales, excluding kennel activities or outside storage of animals							X		X		
Pharmaceutical sales						X	X		X		

ZONING

§ 42-63

TABLE OF PERMITTED AND CONDITIONAL USES

<i>Permitted Uses</i>	<i>RR</i>	<i>R-15 R-10 R-6</i>	<i>R-5 R-5A</i>	<i>R-6A</i>	<i>O &amp; I</i>	<i>C-1</i>	<i>CB</i>	<i>HS(P)</i>	<i>C(P) C-3</i>	<i>M-1</i>	<i>M(P) M-2</i>
Photography, commercial							X		X		
Plant husbandry, including sale of produce raised on premises									X	X	X
Post office					X	X	X		X		
Printing and reproduction					X		X		X		X
Private recreation or swimming club, nonprofit	C	C	C	C	X	X		X			
Public recreation (such as neighborhood center buildings, parks, museums, playgrounds), on a nonprofit basis and similar facilities operated	C	C	C	C	C	C	X	C	C		
Public and community utility stations or sub-stations	C	C	C		C	C		C	C		X
Public utility works, shops or storage yards									X		X
Quarry operations											C
Radio or television studio activities only					X		X		X		
Radio or television transmitting and receiving stations and towers (studios not included)	C	C	C	C	C				C		X
Railroad station operations									X		X
Railroad yard operations											X
Reducing salon care					X	X	X		X		
Recreation or amusement enterprise conducted inside a building and for profit, and not otherwise listed herein							X	X	X		
Recreation or amusement enterprise conducted outside a building and for profit, and not otherwise listed herein									X	X	
Religious worship activities	X	X	X	X	X	X	X		X		

§ 42-63

SPRING LAKE MUNICIPAL CODE



TABLE OF PERMITTED AND CONDITIONAL USES

Permitted Uses	RR	R-15 R-10 R-6	R-5 R-5A	R-6A	O & I	C-1	CB	HS(P )	C(P) C-3	M-1	M(P) M-2
Repair, rental, and/or servicing of any product the retail sale of which is a use-by-right in the same district						X	X		X		X
Restaurant						X	X	X	X		
Retailing or servicing with operations conducted and merchandise stored entirely within a building and not otherwise listed herein							X		X		
Riding academy activity	X										
Rooming house operation		C	C		C						
Sawmill or planing activities											X
Secondhand, pawn and swap shop sales							X		X		X
School, business and commercial							X		X		
School for nurses or other medically oriented profession	C	C	C	C	X		X		X		
School, private, elementary or secondary	C	C	C	C	C						
School, public	C	C	C		C						
School, trade or vocational							X		X		
Secondhand sales							X		X		
Sheet metal fabrication											X
Sign (See article XI of this chapter)											
Solid waste disposal facilities	C										C
Special information sign, insert	C	C	C	C	C	C	X	C	C	C	C
Storage, flammable											X
Storage, open											X
Storage warehouse											X
Tailoring (dressmaking)						X	X		X		
Taxicab stand operations							X		X		
Teaching of art, music, dance, dramatics, or other fine arts					X	X	X		X		

ZONING

§ 42-63

TABLE OF PERMITTED AND CONDITIONAL USES

Permitted Uses	RR	R-15 R-10 R-6	R-5 R-5A	R-6A	O & I	C-1	CB	HS(P)	C(P) C-3	M-1	M(P) M-2
Telephone exchange operations	C	C	C	C	X	X	X		X		X
Temporary construction building (including mobile structures, see section 42-64)	X	X	X	X	X	X	X	X	X		X
Theater productions, indoor							X	X	X		
Theater productions, outdoor	C								C		
Tire recapping											X
Tobacco, retail sales									X		
Tobacco processing											X
Tobacco sales warehouse											X
Trades contractor activities excluding outside storage of equipment or supplies							X		X		X
Trades contractor activities with outside storage of equipment or supplies											X
Trading stamp redemption							X		X		X
Trailer rentals									X		X
Transient lodgings							X	X	X		X
Truck terminal activities repair and hauling and/or storage									X		X
Upholstering or furniture refinishing								X	X	X	X
Variety, gift and hobby supply sales						X	X		X		
Vehicle (commercial, government) repair or storage									X		X

§ 42-63

SPRING LAKE MUNICIPAL CODE



TABLE OF PERMITTED AND CONDITIONAL USES

Permitted Uses	RR	R-15 R-10 R-6	R-5 R-5A	R-6A	O & I	C-1	CB	HS(P)	C(P) C-3	M-1	M(P) M-2
Vending machine rental											
Warehouse (See Storage warehouse)											
Wholesale sales with operations conducted and merchandise stored entirely within a building and not otherwise listed herein											

<sup>1</sup>Special use permit required for mixed use building, see section 42-91(f), except for CB district – see Sec. 42-35.

<sup>2</sup>In conjunction with a restaurant or bar/nightclub only.

(Code 1978, § 12.88; Code 1995, § 156.035; Ord. of 1-10-1972; Ord. of 7-2-1973; Ord. of 9-26-1983; Ord. of 10-10-1994; Ord. of 9-11-1995; Ord. of 4-23-2001, § 156-035; Ord. of 3-13-2006, § 156.035; Ord. No. 2007-2, § 156.035, 11-26-2007; Ord. No. 2007-5, § 156.035, 11-26-2007; Ord. No. 2009-11, § 3, 5-26-2009; Ord. No. 2009-19, § 156.032, 12-14-2009)

ZONING

§ 42-63

AMEND ARTICLE VII. PLANNED DISTRICTS, Sec. 42-168. Specifications for certain planned districts as indicated below:

#### ARTICLE VII. PLANNED DISTRICTS

##### Sec. 42-168. Specifications for certain planned districts.

Plans for the ~~Central Business District (CB)~~, the Planned Highway Service District HS(P), the Planned Commercial District C(P), and the Planned Industrial District M(P) must meet all of the general provisions and the yard, lot, parking, building, sign, and other requirements pertaining to these districts as contained in this chapter. In addition, recommendations will be obtained from the county planning department and considered by the board of aldermen who may require that additional information be shown which is needed to properly evaluate the merits of the proposed development as to the adherence to the general land use plan and the impact of the proposed development on surrounding land uses.

Secs. 42-169—~~42-173~~ ~~42-189~~. Reserved

AMEND ARTICLE VII. PLANNED DISTRICTS, by CREATING a new section numbered Sec. 42-174, entitled: *Specifications for the CB central business district*, with the contents to read as provided below:

#### ARTICLE VII. PLANNED DISTRICTS

##### Sec. 42-174. Specifications for the CB central business district.

Plans for the CB central business district must comply with the below provisions along with other general provisions contained within this chapter. Incorporated by reference herein, the provisions of the *Façade Improvement Guide For: The Town of Spring Lake, North Carolina (undated)*, hereinafter "façade guide," shall be the prevailing standard for all development, change-in-use and re-development within this district.

- (a) Uses allowed. Only those uses specifically allowed within the CB central business district as specified in Article III shall be considered for development regardless whether new development, change-in-use or redevelopment, except that alcohol sales shall only be allowed as open beverages served in a restaurant or bar/nightclub.
- (b) Development standards. The provisions below shall apply to all new construction; renovation and/or remodeling of the exterior areas of any structure or property shall comply with the below provisions to the extent practicable.



(1) Lot dimensions and setbacks.

- a. The minimum lot area shall be 10,000 square feet for any new divisions of property, except where specifically approved otherwise by the board of aldermen and when the application can show that the intent of the district regulations can be met.
- b. Front and corner side setbacks shall be as required by this ordinance, specific allowances shall be given to ensure consistency with the setbacks of the adjacent and nearby buildings, and provided that the improvements and amenities required by the following sub-sections are provided.

*[Note: Provisions exist in the ordinance for allowing the same or average setback of non-residential buildings within the same block in addition to the standard dimensional provisions.]*

- c. When not connected to an adjacent structure, side yard setbacks shall provide for adequate site distance for vehicular traffic entering and exiting the subject and adjacent properties when a drive or side street is present or a minimum of 20 feet.
- d. Where adjacent to a service alley or another non-residential zoning district, the rear yard shall be a minimum of three feet, and when adjacent to residential zoning, the rear yard shall be a minimum of 20 feet.

(2) Structural dimension and site layout specifications.

- a. It is imperative that the developer and/or their design professional consult the façade guide and implement the provisions of said document into their proposed plans. The staff review of any development under the provisions of this section shall ensure that the purpose and intent of the guide are met or will be met upon construction prior to presentation of the proposed plans to the board of aldermen. Any criteria established within the guide that is not or cannot be implemented into the development, re-development or change-in-use project shall be specifically noted in the staff report when the project is presented to the board of aldermen.
- b. The maximum building height shall be 36 feet or a maximum of two stories, whichever is less; except where otherwise specifically approved by the board of aldermen when it has been determined that a proposed building higher than two stories would not pose an obstruction to air traffic.

c. Developers of properties located on corner lots at all street intersections shall locate motor vehicle oriented uses or facilities, including but not limited to gas pumps, drive-throughs, pick-up windows, or other accessory uses intended for access while inside a vehicle to the side not facing the street or rear of the principal building. In no instance shall a motor vehicle oriented feature or accessory use be located between a principal building and the street it fronts.

(3) Pedestrian pathways/sidewalks and amenities.

a. All pedestrian pathways shall be established in order to connect internal and external development and all proposed pathways shall be included on the site plan. Types of sidewalks may include: public, private with public access easement, or private (internal pathways from parking to building entrances or building to building).

b. Sidewalks shall be constructed in compliance with *American with Disabilities Act (ADA)* provisions. Adjacent to the sidewalk opposite from the curbside, a minimum six foot grass, tree and landscaping area shall be provided where on-street parking is not provided; and with the number and types of trees and landscaping meeting or exceeding the standards of this ordinance. A storefront and clear walkway area shall be constructed along the entire building front. This storefront/walkway area shall be designed in such manner that it affords safe pedestrian passage, can accommodate amenities such as benches, potted flowers or plants and may be partially covered by awnings or porticos.

c. Pedestrian walkways should be delineated from any off-street parking area by separate paved routes using a variation in paved texture and/or color, and protected from adjacent vehicle circulation areas.

d. Where sidewalk construction is not feasible due to a change-in-use or redevelopment, the developer shall pay a fee in lieu of sidewalk construction in an amount consistent with the actual cost of installing the sidewalk. The monies generated from this section shall be used by the town for sidewalk construction and/or maintenance of sidewalks within the central business district CB. [Note: Must first be coordinated with Town Finance before submitting for approval.]

(4) Landscaping.

a. Flowering street trees shall be provided in an amount equivalent to at least one tree for every 20 feet of road frontage and shall be located within the amenity area required in sub-section 3(b) above including along any side



street. In the event a non-flowering tree is proposed to be planted that would be conducive to the proposed development, specific approval from the board of aldermen for the alternative tree specimens is mandatory. All street trees shall be a minimum of two inch caliper at time of planting. Additional plantings in pots or boxes are strongly encouraged.

b. Developments within this district shall be exempt from the street tree requirements of Article IX of this chapter subject to sub-section (a) above; however, for the yard space and off-street parking areas landscaping shall be required the same as required by Article IX for any proposed development.

(5) Parking and driveways.

a. Off-street parking shall be provided as required by Article X to the rear or side of the principal structure being served. Furthermore, the developer is encouraged to align off-street parking spaces in a manner consistent with adjacent developed non-residential properties and engage in shared parking or using remote parking as allowed by Article X. Where on-street parking is provided immediately adjacent to the property to be developed, such parking immediately adjacent and in front of the lot where the proposed/existing structure is located may be counted toward the calculation of the minimum number of required off-street parking.

b. Off-street parking areas shall be separated from buildings and public sidewalks with decorative amenities, landscaping or grassed open areas or other appropriate means to afford pedestrian safety.

c. For corner lots along Main Street, driveway/service access shall be restricted to the side street.

(6) Interconnectivity.

a. Pedestrian or motor vehicle connections shall be required for new construction and where appropriate for any re-development of properties within the district.

b. Rear alleys for service, utilities and employee access are strongly encouraged and will be mandatory when a proposed development is adjacent to a developed property having an existing alley.

(7) Signage. All signs within the central business district CB shall comply with the dimensional provisions as regulated in Sec. 42-293(2)c. In addition, signage shall contain no more information than to identify the business to which it serves with no other commercial message and shall be constructed of materials consistent

with and complementing the principal structure and other signs in the immediate area as specified in the aforementioned façade guide.

(8) Lighting. All pedestrian areas, including off-street parking areas are to be lighted with shielded, controlled lighting, and shall complement the proposed development in color and style while being consistent with existing lighting of adjacent or nearby developed non-residential properties. The provisions of Section 1102.M shall apply in this district as well as the recommendations of the façade guide.

(9) Open space/public space. Where possible, property owners are encouraged to preserve and provide open space areas, and have the areas delineated on the site plan. If preserved open space or developed public spaces are offered to and accepted by the town, the property owner will receive a density bonus for the equivalent land area outside the main street overlay district. The density bonus shall be calculated at the R10 density rate.

(10) Conflict with other ordinance or regulatory provisions. Wherever there is conflict or inconsistency between the main street overlay district provisions and other regulations with any local, state or federal law, the most restrictive standard shall apply. When the provisions of this district conflict with other provisions of this chapter, the overlay district provisions shall prevail.

Secs. 42-175—42-189. Reserved

**AMEND ARTICLE XI. SIGN REGULATIONS, Sec. 42-293. Signs permitted by districts (2) Professional, commercial and industrial districts, c. CB central business district, as indicated below:**

#### **ARTICLE XI. SIGN REGULATIONS**

**Sec. 42-293. Signs permitted by districts.**

*(2) Professional, commercial and industrial districts.*

*c. CB central business district. Signs for uses permitted in the CB district shall be regulated as follows:*

*1. ~~One~~ ~~Two~~ attached signs ~~is~~ ~~are~~ permitted per occupant business except on through lots or lots having frontage on two or more streets, in which case one ~~two~~ signs per occupant business for each frontage shall be permitted. The*



maximum total area of all signs shall be limited to two square feet per frontage of the lot. ~~When two or more buildings are on the same lot, the sign area will be proportioned in accordance with the frontage of the buildings.~~

2. All signs shall be attached to the principal structure or appurtenance in a manner consistent with the provisions of the *Façade Improvement Guide for: The Town of Spring Lake, North Carolina*. Signs may be placed perpendicular to the building with the lower edge being no less than nine ~~eight~~ feet above the ground. Signs shall not project over public right-of-way.

**AMEND ARTICLE XIII. ADMINISTRATION AND ENFORCEMENT, Sec. 42-359. Zoning permit required; approval of plans; issuance, by CREATING a new sub-section (d), with the contents to read as provided below:**

#### **ARTICLE XIII. ADMINISTRATION AND ENFORCEMENT**

##### **Sec. 42.359. Zoning permit required; approval of plans; issuance.**

(a) It shall be unlawful to commence the excavation for or the construction of any building or other structure, including accessory structures, or to commence the moving, alteration, or repair of any structure or the use of any land or building, including accessory structures, until the zoning inspector has issued a zoning permit for such work or use, including a statement that the plans, specifications, and intended use of such land or structure in all respects conforms with the provisions of this chapter. Application for a zoning permit shall be made in writing to the zoning inspector on forms for that purpose. Zoning permits shall be void after six months from date of issue unless substantial progress on the subject has been made by that time.

(b) It shall be unlawful for the zoning inspector to approve any plans or issue a zoning permit for any purpose regulated by this chapter until he has inspected such plans in detail and found them in conformity with this chapter. To this end, the zoning inspector shall require that every application for a zoning permit be accompanied by a plan or plat drawn to scale and showing the following in sufficient detail to enable the zoning inspector to ascertain whether the proposed activity is in conformance with this chapter:

(1) The actual shape, location, and dimensions of the lot.

(2) The shape, size, and location of all buildings or other structures to be erected, altered, or moved and any buildings or other structures already on the lot.

(3) The existing and intended use of all such buildings or other structures.

(4) Such other information concerning the lot or adjoining lots as may be essential for determining whether the provisions of this chapter are being observed.

(c) If the proposed activity as set forth in the application is in conformity with the provisions of this chapter, the zoning inspector shall issue a zoning permit for such purpose. If any application for a zoning permit is not approved, the zoning inspector shall state in writing on the application the cause for such disapproval. Issuance of a permit shall, in no case, be construed as waiving any provision of this chapter.

(d) All modifications, including changes in use and/or increase in density, to approved plans, other than those listed below, shall be reviewed in the same manner as a new project. The following minor modifications to an existing or approved development may be permitted by the zoning inspector without presentation to the board of aldermen after the inspector's consultation with the county planning staff provided no variance is required, the use does not change to any use not specifically allowed within the zoning district, the intent and layout of the approved plan is generally followed or if an existing development that the site layout does not substantially change, density is not increased, conditions of approval are not violated, and such changes do not cause a significant adverse impact:

(1) Slight variations in the building dimensions that do not depart from the general approved layout and not exceeding ten percent of the original approved dimensions;

(2) Minor changes in parking lot or traffic lane dimensions;

(3) Minor dimensional changes to individual lots;

(4) Minor site modifications due to necessary engineering requirements;

(5) Change of location of elements included on the site plan that generally maintains relative alignment and orientation to the approved site plan;

(6) For any proposed change in use to an existing development, the use is specifically listed as a permitted use within this chapter for the district in which the property is located, no exterior structural changes unless otherwise allowed by the terms of this section, and all resultant standards of this chapter are complied with; and

(7) Other similar insignificant changes.

In reviewing such changes, the zoning inspector and/or county planning staff may require that the modification be handled in the same manner as a new application.

(Code 1978, § 12.119\*b); Code 1995, § 156. 146; Ord. of 1-10-1972)





Patricia Hall,  
Chair  
Town of Hope Mills

Charles C. Morris,  
Vice-Chair  
Town of Linden

Garland C. Hostetter,  
Town of Spring Lake  
Harvey Cain, Jr.,  
Town of Stedman

Donovan McLaurin  
Wade, Falcon & Godwin

Thomas J. Lloyd,  
Director

Cecil P. Combs,  
Deputy Director

Vikki Andrews,  
Diane Wheatley,  
Carl Manning,  
Walter Clark,  
Cumberland County

Benny Pearce,  
Town of Eastover

**CUMBERLAND**  
★ **COUNTY** ★  
NORTH CAROLINA

◆  
*Planning & Inspections Department*

August 12, 2014

**MEMORANDUM**

**TO:** Cumberland County Joint Planning Board  
**FROM:** Planning and Inspections Staff  
**SUBJECT:** Staff Recommendation for the August 19, 2014 Board Meeting

**P14-40.** REZONING OF 3.34+/- ACRES FROM R10 RESIDENTIAL TO O&I(P) PLANNED OFFICE AND INSTITUTIONAL OR TO A MORE RESTRICTIVE ZONING DISTRICT, LOCATED AT 4231 AND 4239 CAMERON ROAD, SUBMITTED BY TIMOTHY EVANS (OWNER).

**1<sup>st</sup> MOTION**

The Planning and Inspections Staff recommends the board find that approval of the request for rezoning in Case No. P14-40 is generally consistent with the adopted comprehensive plan designated as the *2030 Growth Vision Plan*, which calls for “urban” and “conservation” at this location because the district requested will allow for limited amount of neighborhood oriented non-residential uses on relatively large lots for an urban area; as well as meeting the location criteria for “office and institutional” development as listed in the Land Use Policies Plan. Although the request is not entirely consistent with the Southwest Cumberland Land Use Plan Map, which calls for “low density residential” and “open space” at this location, the general area already contains several non-residential uses and will likely trend to more non-residential uses given the recent improvements to Cameron Road and recent rezonings.

The staff also recommends that the board further find that approval of this request for rezoning is reasonable and in the public interest because the district requested will allow for uses the same as or comparable to those uses occurring on the immediate adjacent properties

**2<sup>nd</sup> MOTION**

In addition to the above information, the Planning and Inspections Staff recommends the board approve Case No. P14-40 for O&I(P) Planned Office and Institutional and CD Conservancy District where the Special Flood Hazard Area (SFHA) exists:

- The request is logical as the subject property is located between Cameron Road and US Hwy 301 which may not be appropriate for residential uses.

The applicant has verbally agreed with the staff recommendation. There are no other districts considered suitable for this request.

Attachments: 1 – Site Profile 2 – Sketch Map

**P14-40**  
**SITE PROFILE**

**P14-40.** REZONING OF 3.34+/- ACRES FROM R10 RESIDENTIAL TO O&I(P) PLANNED OFFICE AND INSTITUTIONAL OR TO A MORE RESTRICTIVE ZONING DISTRICT, LOCATED AT 4231 AND 4239 CAMERON ROAD, SUBMITTED BY TIMOTHY EVANS (OWNER).

**Site Information:**

**Frontage & Location:** 626.70'+/- on SR 1131 (Cameron Road)

**Depth:** 314.00'+/-

**Jurisdiction:** Cumberland County

**Adjacent Property:** No

**Current Use:** 2 residential structures

**Initial Zoning:** R10 – November 17, 1975 (Area 4)

**Nonconformities:** If approved, residential structures and use will become nonconforming

**Zoning Violation(s):** None

**Surrounding Zoning:** North: C(P), C1(P), RR, R10, PND & R5A; South: R10/CU (paint & body shop), M(P), HS(P), RR & R10; East: RR & R10; West: R10/CU (warehousing ceiling tiles), RR, R10 & PND

**Surrounding Land Use:** Residential, religious worship (2), trade contractor & woodlands

**2030 Land Use Plan:** Urban & conservancy

**Southwest Cumberland Land Use Plan:** Low density residential & open space (where SFHA exists)

**Special Flood Hazard Area (SFHA):** Yes, base flood is 80 msl (NAVD)

**Water/Sewer Availability:** PWC/Septic

**Soil Limitations:** None

**School Capacity/Enrolled:** E. V. Baldwin Elementary: 790/745; Hope Mills Middle: 740/716; South View High: 1,800/1,784

**Subdivision/Site Plan:** If approved, new development will require a review and approval

**Municipal Influence Area:** Town of Hope Mills

**Average Daily Traffic Count (2010):** 2,800 on SR 1131 (Cameron Road) & 21,000 on US Hwy 301

**Highway Plan:** There are no road improvements/constructions specified for this area. This case has no impact on the current Highway Plan or Transportation Improvement Program

**Notes:**

1. Density minus (15% for R/W):  
R10 (R7.5) – 21 lots/units (18 lots/units)
  
2. Minimum Yard Setback Regulations:

<b><u>R7.5</u></b>	<b><u>O&amp;I(P)</u></b>
Front yard: 30'	Front yard: 35'
Side yard: 10'	Side yard: 15'
Rear yard: 35'	Rear yard: 20'

**First Class and Record Owners' Mailed Notice Certification**

*A certified copy of the tax record owner(s) of the subject and adjacent properties and their tax record mailing address is contained within the case file and is incorporated by reference as if delivered herewith.*



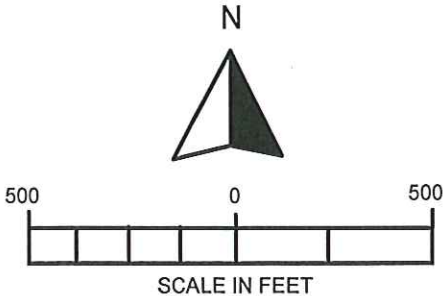
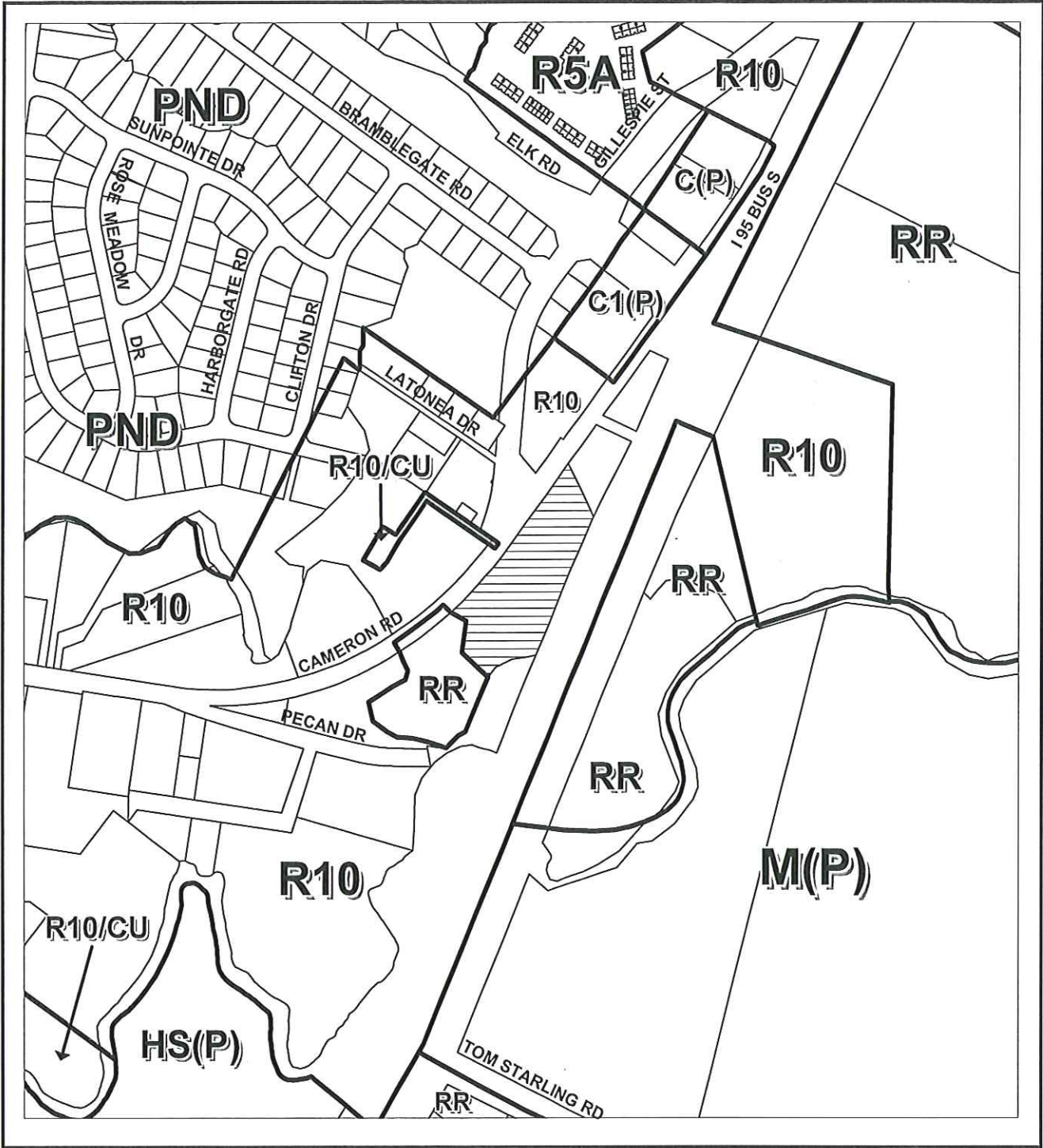

## REQUESTED REZONING R10 TO O&I(P)

<b>ACREAGE: 3.34 AC.+/-</b>		<b>HEARING NO: P14-40</b>	
ORDINANCE: COUNTY	HEARING DATE	ACTION	
STAFF RECOMMENDATION			
PLANNING BOARD			
GOVERNING BOARD			

Patricia Hall,  
Chair  
Town of Hope Mills

Charles C. Morris,  
Vice-Chair  
Town of Linden

Garland C. Hostetter,  
Town of Spring Lake  
Harvey Cain, Jr.,  
Town of Stedman

Donovan McLaurin  
Wade, Falcon & Godwin

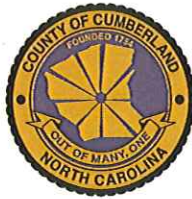

**CUMBERLAND**  
★ **COUNTY** ★  
NORTH CAROLINA

—◆—  
*Planning & Inspections Department*

Thomas J. Lloyd,  
Director

Cecil P. Combs,  
Deputy Director

Vikki Andrews,  
Diane Wheatley,  
Carl Manning,  
Walter Clark,  
Cumberland County

Benny Pearce,  
Town of Eastover

August 12, 2014

**MEMORANDUM**

**TO:** Cumberland County Joint Planning Board  
**FROM:** Planning and Inspections Staff  
**SUBJECT:** Staff Recommendation for the August 19, 2014 Board Meeting

**P14-41. REZONING OF .68+/- ACRE FROM C1(P) PLANNED LOCAL BUSINESS TO RR RURAL RESIDENTIAL OR TO A MORE RESTRICTIVE ZONING DISTRICT; LOCATED ON THE NORTHEAST SIDE OF NC HWY 87 (N BRAGG BLVD), NORTH OF MARANATHA CIRCLE; SUBMITTED BY MARY ANN TEW (OWNER) AND RICHARD DANIELS.**

**1<sup>st</sup> MOTION**

The Planning and Inspections Staff recommends the board find that approval of the request for rezoning in Case No. P14-41 is generally consistent with the adopted comprehensive plan designated as the *2030 Growth Vision Plan*, which calls for “urban” and “conservation” at this location because the district requested will allow for single and multi-family dwelling units and a limited amount of neighborhood oriented non-residential uses on relatively large lots for an urban area; as well as meeting the location criteria for “suburban density residential” development as listed in the Land Use Policies Plan. Although the request is not entirely consistent with the Spring Lake Area Detailed Land Use Plan, which calls for “low density residential” at this location, the district requested is consistent with the zoning of the immediate adjacent properties.

The staff also recommends that the board further find that approval of this request for rezoning is reasonable and in the public interest because the district requested will prevent the overcrowding of the property and lessen congestion in the streets in an area prone to congestion, the uses allowed will be the same as or comparable to those uses allowed on the immediate adjacent properties

**2<sup>nd</sup> MOTION**

In addition to the above information, the Planning and Inspections Staff recommends the board approve Case No. P14-41 for RR Rural Residential zoning based on the following:

- The requested district would be a logical extension of adjacent residentially zoned property under the same ownership.

There are no other districts considered suitable for this request.

**Attachments:**

- 1 – Site Profile
- 2 – Sketch Map



**P14-41**  
**SITE PROFILE**

**P14-41.** REZONING OF .68+/- ACRE FROM C1(P) PLANNED LOCAL BUSINESS TO RR RURAL RESIDENTIAL OR TO A MORE RESTRICTIVE ZONING DISTRICT; LOCATED ON THE NORTHEAST SIDE OF NC HWY 87 (N BRAGG BLVD), NORTH OF MARANATHA CIRCLE; SUBMITTED BY MARY ANN TEW (OWNER) AND RICHARD DANIELS.

**Site Information:**

**Frontage:** 151.26'+/- on NC Hwy 87 (N Bragg Blvd)

**Depth:** 200.96'+/-

**Jurisdiction:** Cumberland County

**Adjacent Property:** Yes, north of subject property

**Current Use:** Woodlands

**Initial Zoning:** C1(P) – January 7, 1974 (Area 11)

**Nonconformities:** Yes, accessory structure on adjacent property appears to encroach onto subject

**Zoning Violation(s):** None

**Surrounding Zoning:** North: RR; South: C(P), C1(P), RR (SL), R10 (SL), R6 (SL) & R5 (SL); East: RR & R10 (SL); West: RR & R6A

**Surrounding Land Use:** Residential (including manufactured dwellings), convenience retail w/ gasoline sales & woodlands

**2030 Land Use Plan:** Urban

**Spring Lake Area Detailed Land Use Plan:** Low density residential

**Special Flood Hazard Area (SFHA):** None

**Water/Sewer Availability:** Well/Septic

**Soil Limitations:** None

**School Capacity/Enrolled:** Manchester Elementary: 340/393; Spring Lake Middle: 700/457; Pine Forest High: 1,750/1,634

**Subdivision/Site Plan:** If approved, new development may require review and approval; recombination plat to cure nonconformity

**Municipal Influence Area:** Town of Spring Lake

**Average Daily Traffic Count (2010):** 30,000 on NC Hwy 87 (N Bragg Blvd)

**US Fish & Wildlife & RLUAC:** No objection to rezoning; however, concerned about loss of trees for dispersal corridor for red-cockaded woodpeckers

**Highway Plan:** N Bragg Blvd is identified in the Highway Plan as a Principal Arterial. There are no road improvements/constructions specified for this area. This case has no impact on the current Highway Plan or Transportation Improvement Program

**Notes:**

1. Density (minus 15% for ROW):  
RR – 2 lots/units (1 lot/unit)
  
2. Minimum Yard Setback Regulations:

<u>RR</u>	<u>C1(P)</u>
Front yard: 30'	Front yard: 45'
Side yard: 10'	Side yard: 15'
Rear yard: 35'	Rear yard: 20'

**First Class and Record Owners' Mailed Notice Certification**

*A certified copy of the tax record owner(s) of the subject and adjacent properties and their tax record mailing address is contained within the case file and is incorporated by reference as if delivered herewith.*

# FORT BRAGG MILITARY RESERVATION

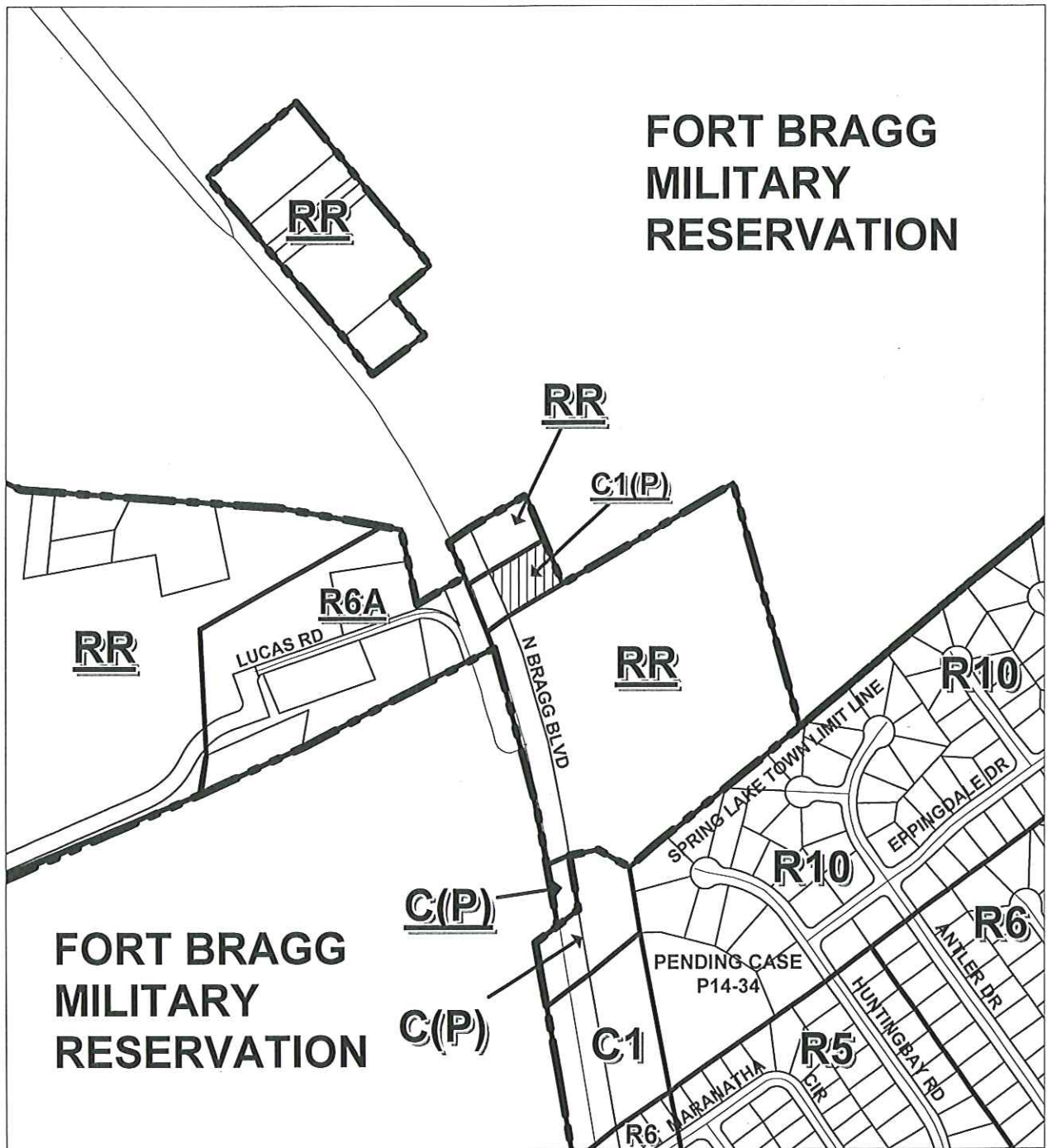

FORT BRAGG  
MILITARY  
RESERVATION

## REQUESTED REZONING C1(P) TO RR

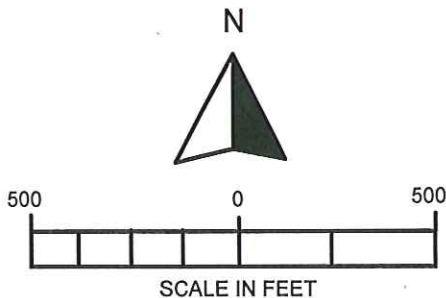

PIN: 0503-20-6521

ACREAGE: 0.68 AC.+/-	HEARING NO: P14-41	
ORDINANCE: COUNTY	HEARING DATE	ACTION
STAFF RECOMMENDATION		
PLANNING BOARD		
GOVERNING BOARD		

7-25-14  
AM



Patricia Hall,  
Chair  
Town of Hope Mills

Charles C. Morris,  
Vice-Chair  
Town of Linden

Garland C. Hostetter,  
Town of Spring Lake  
Harvey Cain, Jr.,  
Town of Stedman

Donovan McLaurin  
Wade, Falcon & Godwin



**CUMBERLAND**  
★ **COUNTY** ★  
NORTH CAROLINA

—◆—  
*Planning & Inspections Department*

August 12, 2014

Thomas J. Lloyd,  
Director

Cecil P. Combs,  
Deputy Director

Vikki Andrews,  
Diane Wheatley,  
Carl Manning,  
Walter Clark,  
Cumberland County

Benny Pearce,  
Town of Eastover

**MEMORANDUM**

**TO:** Cumberland County Joint Planning Board  
**FROM:** Planning and Inspections Staff  
**SUBJECT:** Staff Recommendation for the August 19, 2014 Board Meeting

**P14-42.** REZONING OF 1.72+/- ACRES FROM RR RURAL RESIDENTIAL/CZ CONDITIONAL ZONING FOR A SWEEPSTAKES/INTERNET CAFÉ TO A1 AGRICULTURAL OR TO A MORE RESTRICTIVE ZONING DISTRICT, LOCATED AT 3451 CHICKEN FOOT ROAD, SUBMITTED BY MANLY ALAN AND JUDY S. BOYKIN (OWNERS).

**1<sup>st</sup> MOTION**

The Planning and Inspections Staff recommends the board find that approval of the request for rezoning in Case No. P14-42 is consistent with the adopted comprehensive plan designated as the *2030 Growth Vision Plan* because the Plan calls for “rural” development at this location requiring large lot with a limited type of non-residential uses such as those allowed in the A1 district, and the request meets the location criteria for “rural density residential” as listed in the Land Use Policies Plan.

The staff also recommends the board further find that approval of this request for rezoning is reasonable and in the public interest because, if approved, the requested district will allow for lot sizes and uses comparable to those in the surrounding area.

**2<sup>nd</sup> MOTION**

In addition to the above information, the Planning and Inspections Staff recommends the board approve Case No. P14-42 for A1 Agricultural based on the following:

1. If approved, the rezoning would remove the conditional zoning district allowing for a sweepstakes/internet café which is no longer in operation at this site; and
2. The requested district will allow for the re-use of the existing non-residential structure in a manner consistent with uses that are currently allowed on the surrounding properties.

There are no other districts considered suitable for this request.

**Attachments:**

- 1 – Site Profile
- 2 – Sketch Map

**P14-42**  
**SITE PROFILE**

**P14-42.** REZONING OF 1.72+/- ACRES FROM RR RURAL RESIDENTIAL/CZ CONDITIONAL ZONING FOR A SWEEPSTAKES/INTERNET CAFÉ TO A1 AGRICULTURAL OR TO A MORE RESTRICTIVE ZONING DISTRICT, LOCATED AT 3451 CHICKEN FOOT ROAD, SUBMITTED BY MANLY ALAN AND JUDY S. BOYKIN (OWNERS).

**Site Information:**

**Frontage & Location:** 244.50'+/- on SR 2254 (Odom Road) & 280.50'+/- on SR 2252 (Chicken Foot Road)

**Depth:** 492.17'+/-

**Jurisdiction:** Cumberland County

**Adjacent Property:** Yes, north of subject property

**Current Use:** Religious worship

**Initial Zoning:** A1 – June 25, 1980 (Area13); rezoned to RR/CZ for sweepstakes/internet café on September 15, 2011

**Nonconformities:** Yes, religious worship not allowed in current zoning district

★ **Zoning Violation(s):** Yes, # ZN 628-2014

**Surrounding Zoning:** North: R40A & A1; South: C(P)/CZ (convenience store, restaurant & indoor recreation) & A1; East & West: A1

**Surrounding Land Use:** Residential (including manufactured dwellings), substation, convenience container & recycling facility, farmland & woodlands

**2030 Land Use Plan:** Rural

**Special Flood Hazard Area (SFHA):** None

**Water/Sewer Availability:** Well/Septic

**Soil Limitations:** None

**Watershed:** Yes

**School Capacity/Enrolled:** Gray's Creek Elementary: 495/440; Gray's Creek Middle: 1,100/1,067; Gray's Creek High: 1,270/1,271

**Subdivision/Site Plan:** If approved, new non-residential development may require review and approval

**Average Daily Traffic Count (2010):** 640 on SR 2254 (Odom Road) & 3,100 on SR 2252 (Chicken Foot Road.)

**Highway Plan:** There are no road improvements/constructions specified for this area. This case has no impact on the current Highway Plan or Transportation Improvement Program

**Note:**

Minimum Yard Setback Regulations:

A1

Front yard: 50'

Side yard: 20'

Rear yard: 50'

**First Class and Record Owners' Mailed Notice Certification**

*A certified copy of the tax record owner(s) of the subject and adjacent properties and their tax record mailing address is contained within the case file and is incorporated by reference as if delivered herewith.*



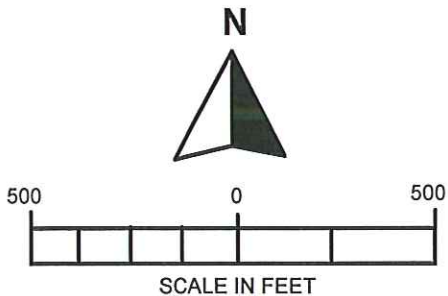
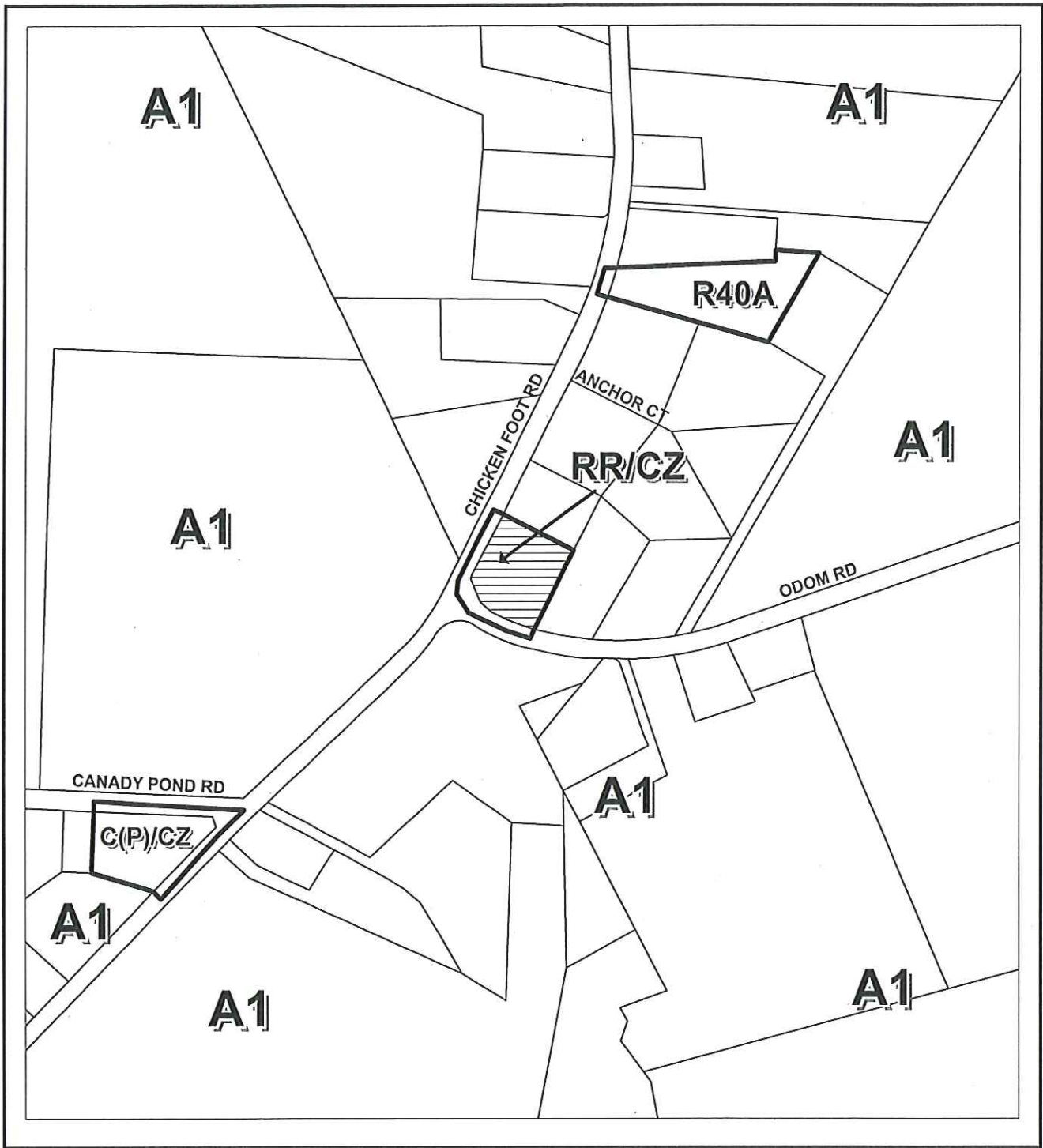

PIN: 0430-19-9877

## REQUESTED REZONING RR/CZ TO A1

<b>ACREAGE: 1.72 AC.+/-</b>	<b>HEARING NO: P14-42</b>	
ORDINANCE: COUNTY	HEARING DATE	ACTION
STAFF RECOMMENDATION		
PLANNING BOARD		
GOVERNING BOARD		

Patricia Hall,  
Chair  
Town of Hope Mills

Charles C. Morris,  
Vice-Chair  
Town of Linden

Garland C. Hostetter,  
Town of Spring Lake  
Harvey Cain, Jr.,  
Town of Stedman

Donovan McLaurin  
Wade, Falcon & Godwin



**CUMBERLAND**  
★ **COUNTY** ★  
NORTH CAROLINA

*Planning & Inspections Department*

August 12, 2014

Thomas J. Lloyd,  
Director

Cecil P. Combs,  
Deputy Director

Vikki Andrews,  
Diane Wheatley,  
Carl Manning,  
Walter Clark,  
Cumberland County

Benny Pearce,  
Town of Eastover

**MEMORANDUM**

**TO:** Cumberland County Joint Planning Board  
**FROM:** Planning & Inspections Staff  
**SUBJECT:** Staff Recommendation for the August 19, 2014 Board Meeting

**P13-45.** MODIFICATION OF A CONDITION FOR AN APPROVED A1 AGRICULTURAL/CZ CONDITIONAL ZONING FOR AN OUTDOOR FIRING RANGE AND AGRICULTURAL USES CONSISTING OF 978.40 +/- ACRES, ALLOWING FOR HOURS OF OPERATION NOT APPLY TO LAW ENFORCEMENT QUALIFICATION AND TRAINING; LOCATED AT 2850 TIGERSWAN DRIVE; SUBMITTED BY D. STEWART PRECYTHE ON BEHALF OF PRECYTHE PROPERTIES, LLC. (OWNER) AND STEVEN M. SWIERKOWSKI ON BEHALF OF THE RANGE COMPLEX.

On July 15, 2014 the Planning Board deferred this case (P13-45) until their regular August 19, 2014 meeting in order to give the applicant/owner an opportunity to provide the board with more information regarding the hours of operation. The staff is not offering a recommendation on this matter.

July 8, 2014 Staff Recommendation

On October 21, 2013 the County Board of Commissioners approved the above referenced rezoning subject to several conditions. One condition restricted night firing and the owner is requesting to modify this condition. The Planning & Inspections Staff recommends approval of the modification to the A1 Agricultural/CZ Conditional Zoning district for an outdoor firing range and agricultural uses, specifically Condition No. 26, for this request based on the following:

- Modifying the hours of operation to allow law enforcement officers access to the range(s) is in the public interest, affording the public's safety and welfare. Mandatory training and qualifications for law enforcement officials who work second and third shifts is difficult and burdensome. Most ranges in Cumberland County are closed when these officers are able to train. It would be logical to allow law enforcement officers who work an off shift the same benefit as those who work 8 am to 5 pm.

**Attachments:**

- 1-Site Profile
- 2-Sketch Map
- 3-Overall Site Plan
- 4&5-Detailed Enlargements
- 6- Conditions of Approval
- 7- Modification Request w/ Requested Hours



**P13-45**  
**SITE PROFILE**

**P13-45.** MODIFICATION OF A CONDITION FOR AN APPROVED A1 AGRICULTURAL/CZ CONDITIONAL ZONING FOR AN OUTDOOR FIRING RANGE AND AGRICULTURAL USES CONSISTING OF 978.40 +/- ACRES, ALLOWING FOR HOURS OF OPERATION NOT APPLY TO LAW ENFORCEMENT QUALIFICATION AND TRAINING; LOCATED AT 2850 TIGERSWAN DRIVE; SUBMITTED BY D. STEWART PRECYTHE ON BEHALF OF PRECYTHE PROPERTIES, LLC. (OWNER) AND STEVEN M. SWIERKOWSKI ON BEHALF OF THE RANGE COMPLEX.

**Site Information:**

**Frontage & Location:** 20.00'+/- on SR 2053 (Doe Hill Road)

**Depth:** 13,100.00'+/-

**Jurisdiction:** Cumberland County

**Adjacent Property:** Yes, northeast of subject property

**Current Use:** Range complex, woodlands, and farmlands

**Initial Zoning:** A1 – September 3, 1996 (Area 21); rezoned to A1/CZ for outdoor firing range and agricultural uses on October 21, 2013

**Nonconformities:** None

**Zoning Violation(s):** None

**Surrounding Zoning:** North: R40A, RR & A1; South: A1; East: C3 & A1; West: A1/CU (to allow a professional office) & A1

**Surrounding Land Use:** Residential (including manufactured dwellings), hog farm, agricultural uses, farmland & woodland

**2030 Land Use Plan:** Rural

**Special Flood Hazard Area (SFHA):** None

**Wetlands:** Yes

**Water/Sewer Availability:** Well/Septic

**Soil Limitations:** Yes, hydric – CT Croatan muck, LE Leon sand, PA Pactolus loamy sandy, RA Rains sandy loam & TR Torhunta and Lynn Haven soils

**School Capacity/Enrolled:** Stedman Primary: 200/163; Stedman Elementary: 300/298; Mac Williams Middle: 1,270/1,163; Cape Fear High: 1,425/1,570

**Subdivision/Site Plan:** If approved, "Ordinance Related Conditions" apply

**Average Daily Traffic Count (2010):** 1,600 on NC HWY 210 S

**Highway Plan:** There are no road improvements/constructions specified for this area. This case has no impact on the current Highway Plan or Transportation Improvement Program

**Note:**

- **If approved, the hours of operation (8 am to 5 pm) would not apply law enforcement officers.**

**First Class and Record Owners' Mailed Notice Certification**

*A certified copy of the tax record owner(s) of the subject and adjacent properties and their tax record mailing address is contained within the case file and is incorporated by reference as if delivered herewith.*

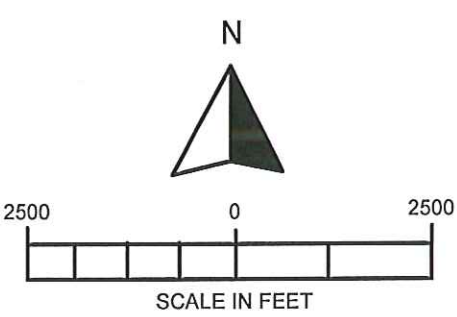
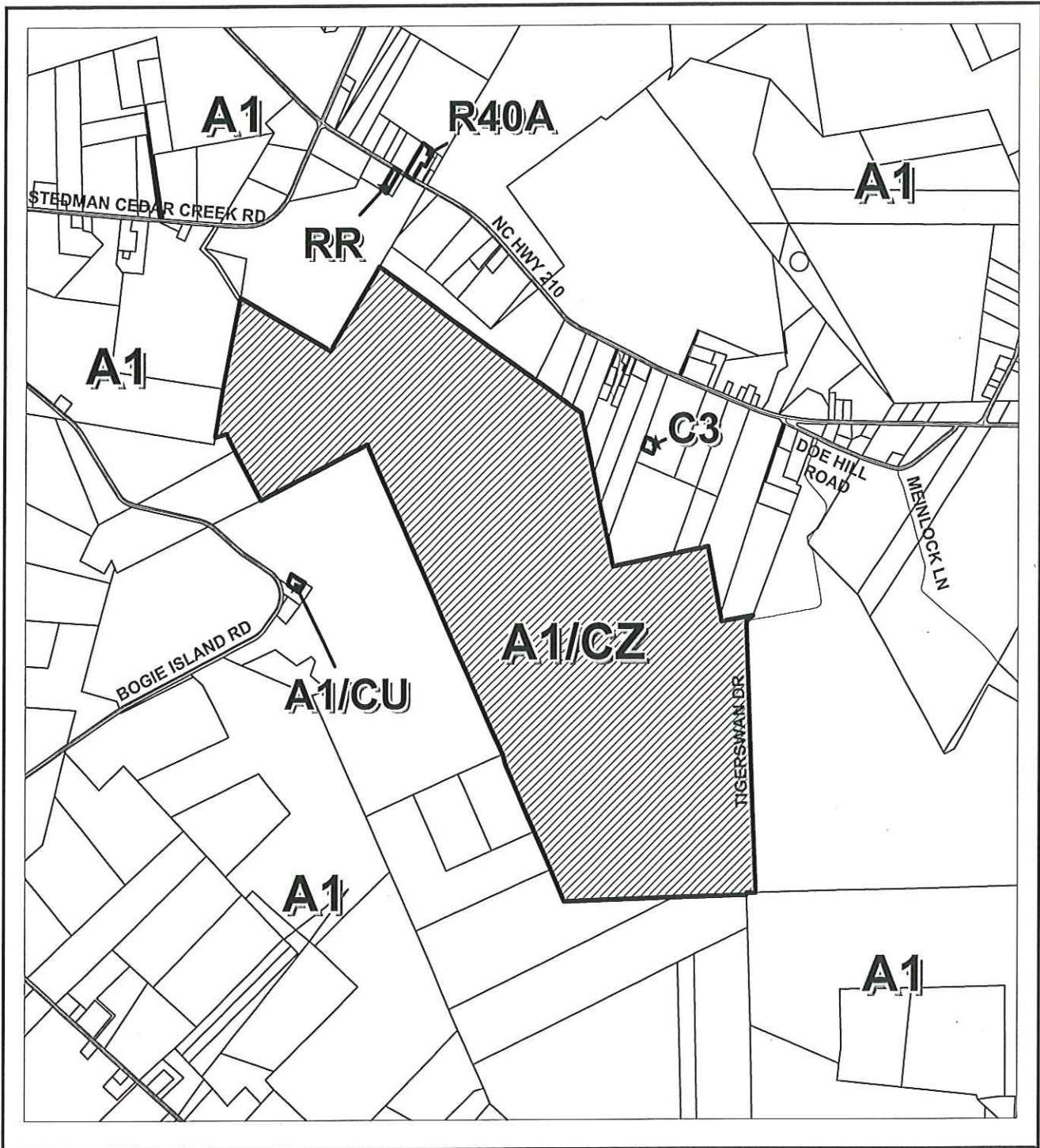

PORT. OF PIN: 0493-04-5262

## MODIFICATION OF CONDITIONAL ZONING

<b>ACREAGE: 978.40 AC. +/-</b>		<b>HEARING NO: P13-45</b>	
ORDINANCE: COUNTY	HEARING DATE	ACTION	
STAFF RECOMMENDATION			
PLANNING BOARD			
GOVERNING BOARD			



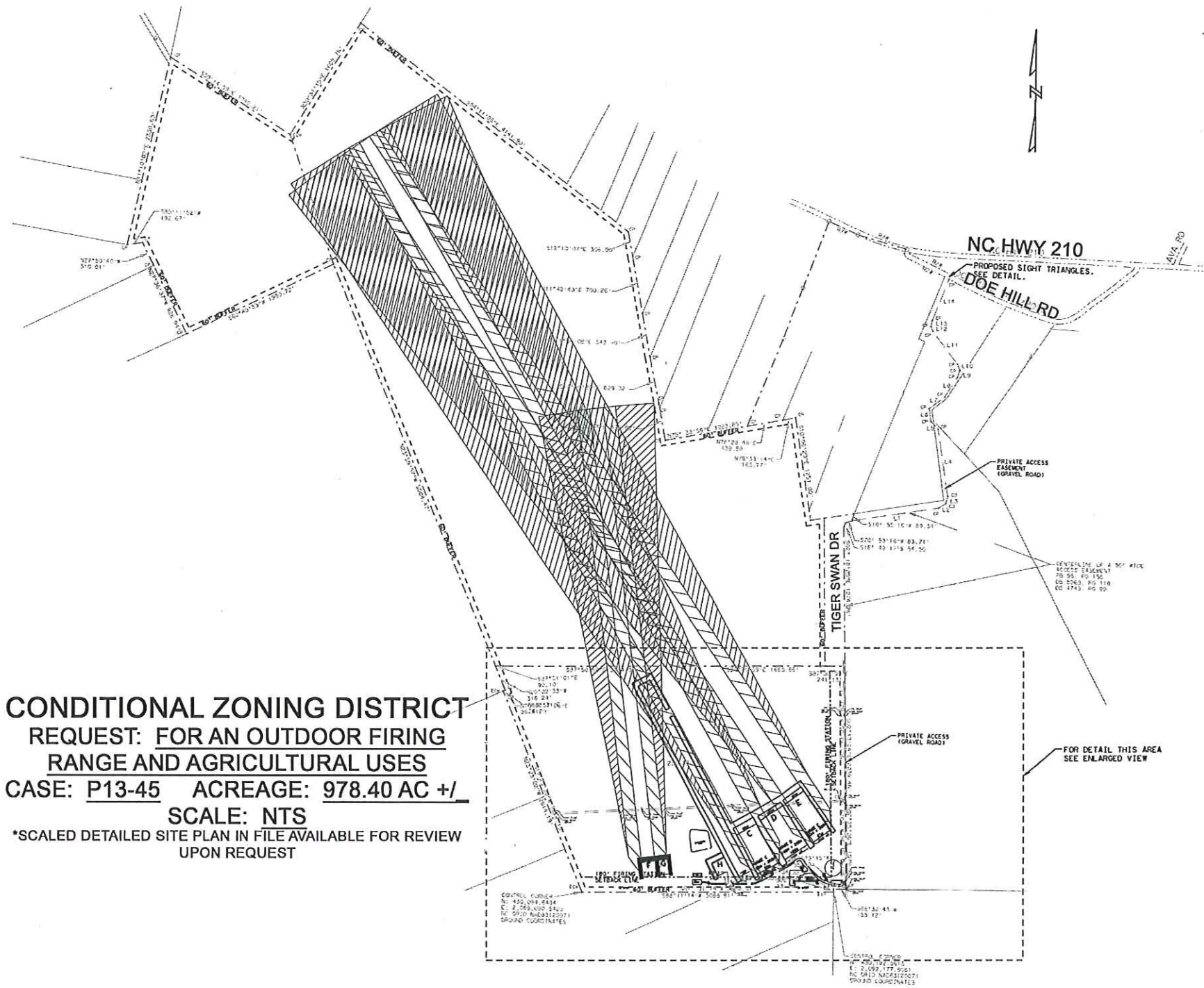

**CONDITIONAL ZONING DISTRICT  
REQUEST: FOR AN OUTDOOR FIRING  
RANGE AND AGRICULTURAL USES**  
**CASE: P13-45 ACREAGE: 978.40 AC +/-**  
**SCALE: NTS**  
 \*SCALED DETAILED SITE PLAN IN FILE AVAILABLE FOR REVIEW  
 UPON REQUEST

CONTROL CORNER  
 N: 430,004.844  
 E: 2,289,400.842  
 PL: 010 (NAD83(2011))  
 GRID COORDINATES

CONTROL CORNER  
 N: 2,092,177.925  
 E: 1,412,145.822  
 PL: 010 (NAD83(2011))  
 GRID COORDINATES

NC HWY 210  
 PROPOSED SIGHT TRIANGLES.  
 SEE DETAIL.  
 DOE HILL RD

PRIVATE ACCESS  
 EASEMENT  
 (GRAVEL ROAD)

CENTRAL LINE OF 4 MO' WIDE  
 ACCESS EASEMENT  
 TO 50' PG 150  
 TO 55' PG 110  
 TO 47' PG 50

FOR DETAIL THIS AREA  
 SEE ENLARGED VIEW

TIGER SWAN DR

PRIVATE ACCESS  
 (GRAVEL ROAD)

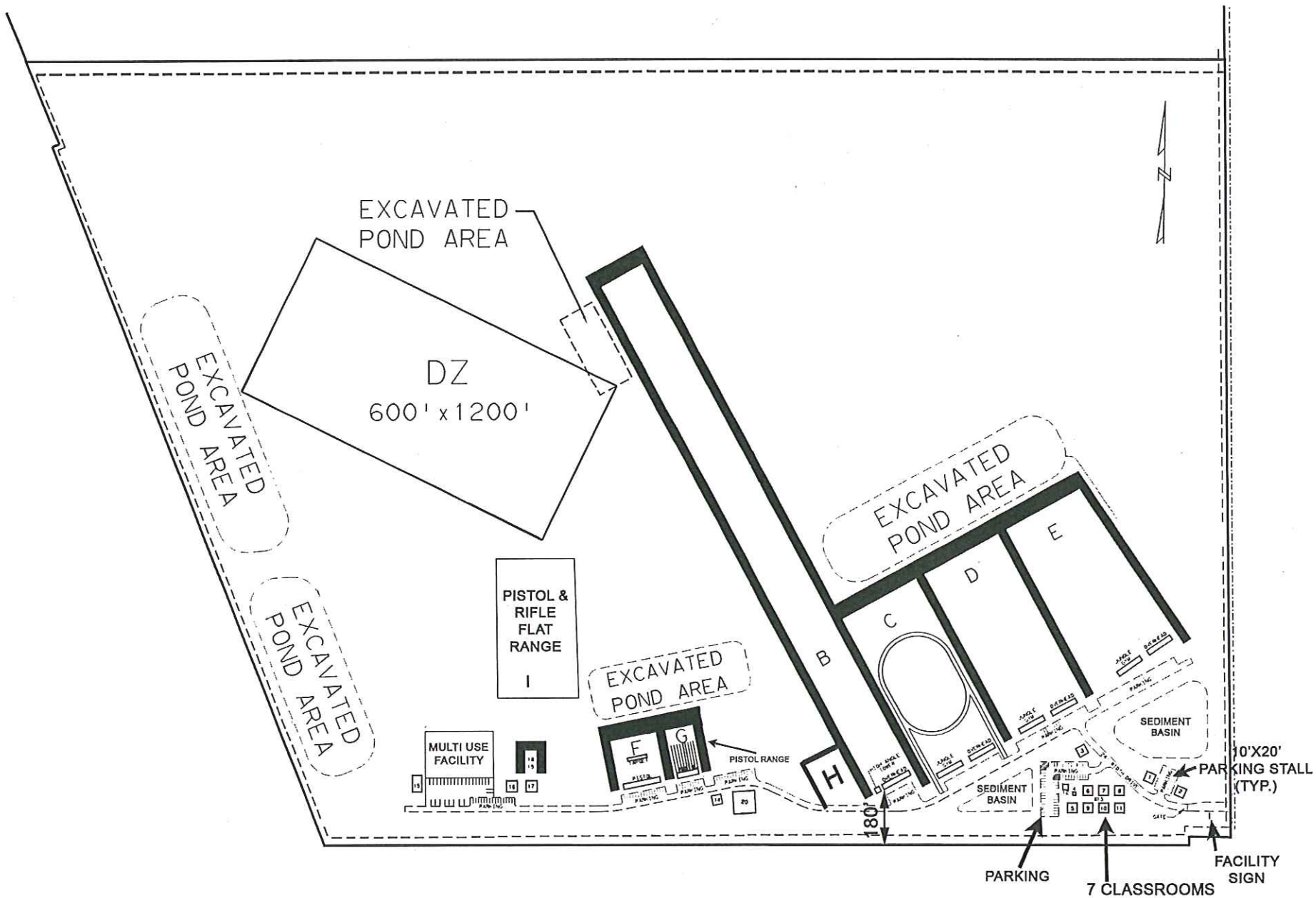

**CASE NO: P13-45**

SCALE: NTS



# P13-45

FACILITY/BUILDING LEGEND				
NO.	DESCRIPTION	APPX. DIMENSIONS (FT X FT)	APPX. FOOTPRINT AREA (50., FT)	REMARKS
1	PRO SHOP, RANGE CHECK-IN	24 X 36	864	
2	BREAK AREA	35 X 35	1225	FUTURE
3	RANGE CTRL BLDG/INSTR.OFF.	24 X 36	864	
4	R-MAG	10 X 20	200	
5	WEAPONS CLEANING AREA	35 X 35	1225	FUTURE
6	CLASSROOM	24 X 36	864	FUTURE
7-8	CLASSROOMS	24 X 36 EACH	864 EACH	
9-11	CLASSROOMS	24 X 36 EACH	864 EACH	FUTURE
12	LATRINE	12 X 36	432	
13	HOLDING TANK	8 X 4	32	

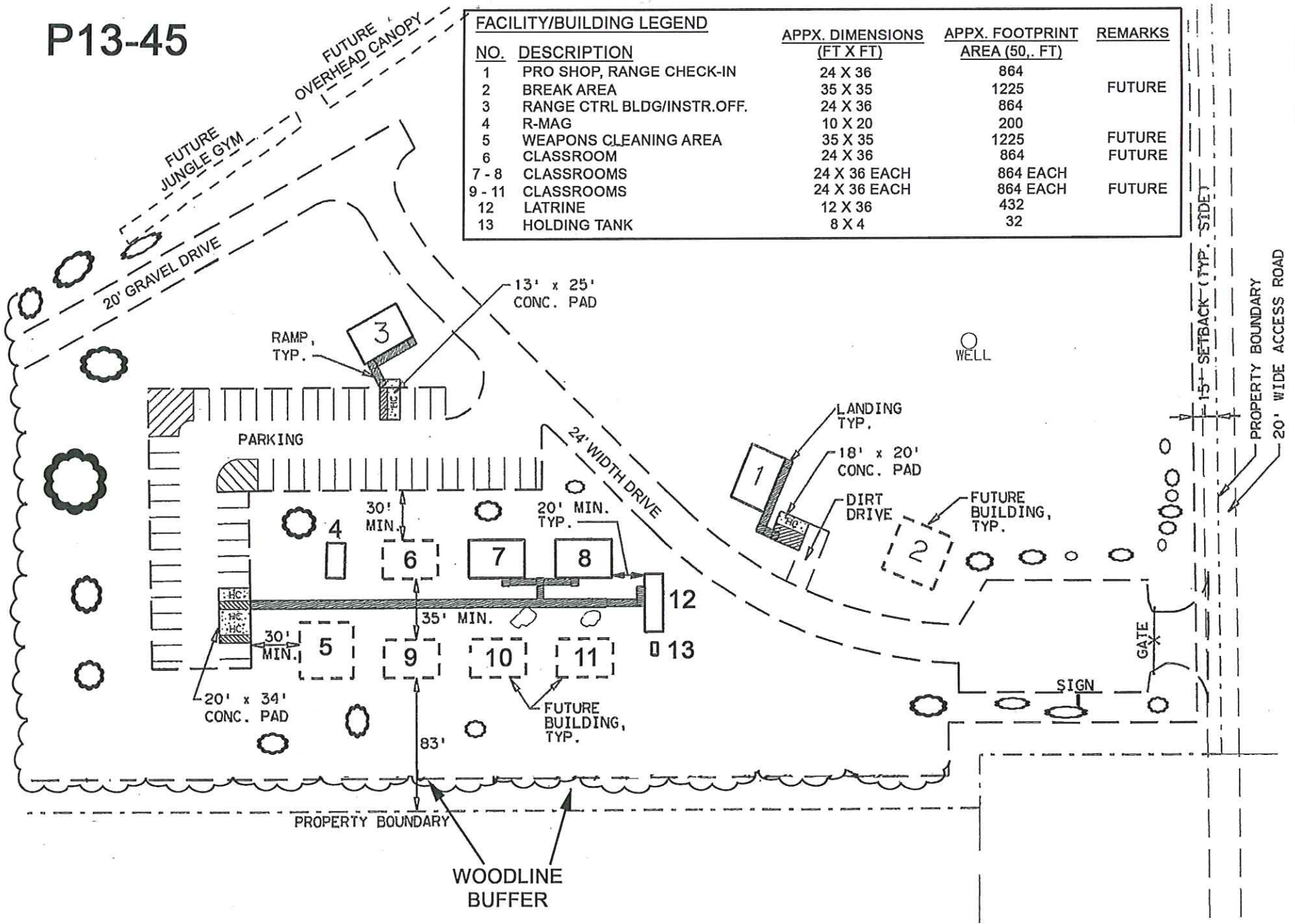

Walter Clark,  
Chair  
Cumberland County

Patricia Hall,  
Vice-Chair  
Town of Hope Mills

Garland C. Hostetter,  
Town of Spring Lake  
Harvey Cain, Jr.,  
Town of Stedman  
Charles C. Morris,  
Town of Linden



CUMBERLAND  
★ COUNTY ★  
NORTH CAROLINA

—◆—  
*Planning & Inspections Department*

Thomas J. Lloyd,  
Director

Cecil P. Combs,  
Deputy Director

Vikki Andrews,  
Diane Wheatley,  
Carl Manning,  
Cumberland County

Benny Pearce,  
Town of Eastover

Donovan McLaurin,  
Wade, Falcon & Godwin

October 22, 2013

David S. Precythe  
P. O. Box 130  
Faison, N. C. 28341

Tigerswan, Inc.  
3452 Apex Peakway  
Apex, N. C. 27502

**SUBJECT:** Case P13-45: Rezoning of 978.40+/- acres from A1 Agricultural to A1/CZ Agricultural/Conditional Zoning district for an outdoor firing range and agricultural uses or to a more restrictive zoning district, located at 2850 Tigerswan Drive, submitted by D. Stewart Precythe on behalf of Precythe Properties, LLC. (owner) and Steven M. Swierkowski on behalf of TigerSwan, Inc.

Dear Applicant,

The Cumberland County Board of Commissioners met on Monday, October 21, 2013 and approved the rezoning of 978.40+/- acres from A1 Agricultural to A1/CZ Agricultural/Conditional Zoning district for an outdoor firing range and agricultural uses request that you submitted, subject to the contents of the application, the site plan and the following conditions:

**Pre- Permit Related:**

1. Prior to any permits being issued, the developer/operator of the firing range shall provide to Code Enforcement documentation of a recorded deed or lease of the subject property in accordance with Section 907.1.B, Firing Ranges, Outdoor, County Zoning Ordinance.

**Permit-Related:**

2. The owner/developer(s) of these lots must obtain detailed instructions on provisions of the County Zoning Ordinance and permits required to place any structure within this development from the County Code Enforcement Section, Room 101 in the Historic Courthouse at 130 Gillespie Street. For additional information, the developer should contact a Code Enforcement Officer.
3. The County Health Department must approve water and sewer plans prior to application for any permits. Site and soil evaluations must be conducted on the property by the County Environmental Health Department prior to application for permits. A copy of the Health Department approval must be provided to Code Enforcement at the time of application for any building/zoning permits. (Note: All Health Department requirements must be met prior to issuance of final permits.) (Section 2306 A, Water and Sewer, County Subdivision and Development Ordinance)



4. The developer must provide a site-specific address and tax parcel number at the time of building/zoning permit application.
5. New development where the developer will disturb or intends to disturb more than one acre of land is subject to the Post-Construction Stormwater Management Permitting Program (Phase II Stormwater Management Requirements) administered by the Division of Water Quality, North Carolina Department of Environment and Natural Resources. If one acre or more of land is to be disturbed, prior to the issuance of any building/zoning permits for this site, a copy of the State's *Post-Construction Permit* must be provided to County Code Enforcement.
6. For any new development where the developer disturbs or intends to disturb more than one acre of land, the developer must provide the Code Enforcement Section with an approved NC Department of Environment and Natural Resources (NCDENR) sedimentation and erosion control plan (S&E) prior to any application for permits. (Note: If any retention/detention basins are required for state approval of this plan, then three copies of a revised plan must be submitted and approved by Planning & Inspections prior to application for any building/zoning permits.) A copy of the NCDENR approval must be provided to Code Enforcement at the time of application for any building/zoning permits.
7. Landscaping must be provided in accordance with Section 1102 N, Landscaping, County Zoning Ordinance. The following are the minimum standards for the required landscaping of this site:
  - Twelve large shade trees or 24 small ornamental trees are required within the parking area.

In addition:

- a. Required plant materials shall be maintained by the property owner, including replacing dead or unhealthy trees and shrubs;
  - b. All yard and planting areas shall be maintained in a neat, orderly, and presentable manner and kept free of weeds and debris; and
  - c. The required plantings may be phased in as the off-street parking areas are provided.
8. Prior to application for final inspection, the developer/operator of the firing range facility is required to provide to Code Enforcement at the time of application for the building final inspection, a certification prepared by a North Carolina registered engineer that the firing range facility has an environmental stewardship plan in accordance with Section 907.1.G, Firing Ranges, Outdoor, County Zoning Ordinance and is in compliance with the Best Management Practices, specifically relating to lead management, as specified by the EPA's most current edition of *Best Management Practices for Lead at Outdoor Shooting Ranges*.
  9. Prior to final inspection, the developer/firing range operator must provide to Code Enforcement proof of general liability insurance coverage in an amount not less than \$3,000,000.00 and this policy is required to be maintained throughout the continued operation of the facility. This policy cannot exclude coverage for property damage or personal injury caused by the discharge of firearms.
  10. A review of the data available to the Army Corp of Engineers indicates that jurisdictional waters are likely to be present on this property and therefore are likely to be impacted by the proposed project. However, without an official Jurisdictional Determination at the property, these findings cannot be confirmed.

A permit will be required for this project if construction will involve the temporary and/or permanent placement of fill in waters of the United States including wetlands. If a permit is required, the applicant will be required to avoid and minimize impacts to wetland/waters of the United States and may need to provide compensatory mitigation for unavoidable impacts.

11. The final inspection cannot be accomplished until a Code Enforcement Officer inspects the site and certifies that the site is developed in accordance with the approved plans.

**Site-Related:**

12. All uses, dimensions, setbacks and other related provisions of the County Subdivision and Development Ordinance and Zoning Ordinances for the A1/CZ zoning district must be complied with, as applicable.
13. This conditional approval is not approval of the permit for any freestanding signs. Attached signage for this development must be in accordance with the applicable sign regulations as set forth in Article XIII of the County Zoning Ordinance and that the proper permit(s) must be obtained prior to the installation of any permanent signs on the property. (Note: This conditional approval is not approval of the size, shape, or location of any signs.)
14. For new development, all utilities, except for 25kv or greater electrical lines, must be located underground. (Section 2306 C, County Subdivision and Development Ordinance)
15. All lighting is required to be directed internally within this development and comply with the provisions of Section 1102 M, Outdoor Lighting, County Zoning Ordinance.
16. A 60 foot wide buffer area, undisturbed except for desired fence installation and vegetative plantings, shall be provided around the entire perimeter of the subject property (Section 907.1.D, Firing Range, Outdoor, County Zoning Ordinance).
17. All dumpster, garbage, and utility areas shall be located on concrete pads and screened on a minimum of three sides.
18. All required off-street parking spaces shall be a minimum of 9' x 20'; a minimum of one off-street parking space for each four persons in design capacity for the firing range is required for this development  
  
(Note: Under the current site plan showing 244 off-street parking spaces this will allow for a capacity of 976 persons for zoning purposes. The owner/developer should contact the County Fire Marshal to determine maximum capacity of this development).
19. Compliance with all other applicable Federal, State and local regulations, to include the County's Noise regulations (Chapter 9.5, Article II, Cumberland County Code of Ordinances) is required.
20. This conditional approval is not approval of the use of helicopters or other aircraft at this facility. "Minor airport operations" would require re-submittal of the Conditional Zoning application petitioning the County Commissioners to amend the current approval prior to commencement of any air traffic activity.
21. Control measures are required to be provided on the site to ensure that the potential for rounds/munitions leaving the site are negated.



22. Full compliance with the Firearms Regulations (Chapter 9.5, Article IX, Cumberland County Code of Ordinances) is required as applicable.
23. The developer/operator of the firing range shall not allow unauthorized personnel access to the to the range while firearms are being discharged in accordance with Section 907.1.F, Firing Ranges, Outdoor, County Zoning Ordinance.
24. The developer is encouraged to post warning signs approximately every 100 feet around the perimeter of the site to put potential unintended trespassers on notice of the ranges.
25. The owner/developer is responsible for ensuring easements which may exist on the subject property are accounted for, not encumbered and that no part of this development is violating the rights of the easement holder.
26. At the October 1, 2013 Planning Board meeting, the applicants agreed that normal (daylight) range operations shall only be conducted between the hours of 8:00 am to 5:00 pm. In addition, on no more than five days each calendar month, the hours will extend to 10:00 pm for conducting night fire operations, provided that public notice is given of the extended hours at least 12 hours in advance. The form by which public notice is provided shall be approved by the Planning Director. Under no circumstances, shall range operations be conducted after 10:00 pm.

*Thank you for choosing Cumberland County!*

**If you need clarification of any conditions, please contact Ed Byrne at 910-678-7609 or Patti Speicher at 910-678-7605 with the Land Use Codes Section; otherwise, contact the appropriate agency at the contact numbers below.**

**Contact Information (Area Code is 910 unless otherwise stated):**

Subdivision/Site Plan/Plat	Ed Byrne	678-7609
Code Enforcement (Permits):	Ken Sykes	321-6654
Fire Marshal – Emergency Services	Rodney Ward	321-6625
County Health Department:	Daniel Ortiz	433-3680
Ground Water Issues:	Matt Rooney	678-7625
County Public Utilities:	Amy Hall	678-7637
Corp of Engineers (wetlands):	Crystal C. Amschler	(910) 251-4170
NCDENR (E&S):	Sally Castle	433-3300
Location Services:		
Site-Specific Address:	Ron Gonzales	678-7616
Tax Parcel Numbers:		678-7549
NCDOT (driveways/curb-cuts):	Gary Burton	486-1496
N.C. Division of Water Quality:	Mike Randall	(919) 733-5083 ext. 545

The Range Complex  
2850 TigerSwan Dr  
Autryville NC 28318

June 10, 2014

TO: Cumberland County Board of Commissioners

SUBJECT: Rezoning Case No. P13-45 – Request to Modify a Condition of Approval

The Range Complex (TRC) requests to modify Condition No. 26, specifically the hours of operation. TRC requests an exemption for Law Enforcement qualification and training. TRC requests Law Enforcement be permitted to train /qualify with their assigned weapons at any time. This is to facilitate training/qualification of officers who work night shifts, and allow them to train/qualify at the conclusion of their shift.

Sincerely,



Steve Swierkowski  
Vice President, TRC  
(910) 208-4117



7. STATEMENT OF ACKNOWLEDGMENT:

It is understood by the undersigned that the official zoning map, as originally adopted and subsequently amended, is presumed to be appropriate to the property involved and that the burden of proof for a zoning amendment (rezoning) rest with the petitioner.

It is the responsibility of the petitioner (personally or by agent) to submit to the Planning and Inspections Department a valid request within a complete application.

I further understand I must voluntarily agree to all ordinance related conditions prior to the first hearing on the case or any disagreement may be cause for an unfavorable recommendation. The undersigned hereby acknowledge that the Planning and Inspections Staff has conferred with the petitioner or assigns, and the application as submitted is accurate and correct.

David Stewart Aronthe  
NAME OF OWNER(S) (PRINT OR TYPE)

P.O. Box 130 Faison, NC 2841  
ADDRESS OF OWNER(S)

Stewart@SouthernProduce.com  
E-MAIL

910-590-9500 HOME TELEPHONE      910-2670011 WORK TELEPHONE

[Signature] SIGNATURE OF OWNER(S)      [Signature] SIGNATURE OF OWNER(S)

Steve Swierkowski  
NAME OF AGENT, ATTORNEY, APPLICANT (by assign) (PRINT OR TYPE)

6812 Mumford Drive Fayetteville, NC 28305  
ADDRESS OF AGENT, ATTORNEY, APPLICANT

(910) 237-5287 HOME TELEPHONE      (510) 208-4117 WORK TELEPHONE

Steve.Swierkowski@TheRandyCampbell.com E-MAIL ADDRESS      N/A FAX NUMBER

[Signature]  
SIGNATURE OF AGENT, ATTORNEY, OR APPLICANT

# The Range Complex (TRC) Request

TRC requests Board recommend approval to Cumberland County Commissioners for the following exceptions to the rules imposed on TRC in support of Fayetteville Police Department's (FPD) annual pistol and rifle qualification:

1. TRC requests an exception to: "no more than five days each calendar month, the hours will extend to 10:00 pm for conducting night fire operations"

and

2. TRC requests an exception to: "Under no circumstances, shall range operations be conducted after 10:00 pm."

**TRC requests an exception to the night firing rules imposed by the Cumberland County Commissioners for 3 months each year to support Fayetteville Police Departments annual pistol and rifle qualifications.**



## Limitations Imposed on TRC

26. At the October 1, 2013 Planning Board meeting, the applicants agreed that normal (daylight) range operations shall only be conducted between the hours of 8:00 am to 5:00 pm. In addition, on no more than five days each calendar month, the hours will extend to 10:00 pm for conducting night fire operations, provided that public notice is given of the extended hours at least 12 hours in advance. The form by which public notice is provided shall be approved by the Planning Director. Under no circumstances, shall range operations be conducted after 10:00 pm.

# FPD's Annual Qualification

- Fayetteville Police Department (FPD) will have a maximum of 20 officers shooting per day / night. This allows FPD to qualify everyone in 1 round of fire (day / night), which equates to about 30 minutes of actual shoot time per day / night.
- Rarely will FPD need to go pass 2200 hours
- The 0430 – 1030 / 1630 – 2230 schedule accommodates a variety of shifts and saves money of the officers shoot on a scheduled day of work



# FPD's Annual Qualification Tentative Schedule

Fayetteville PD's Annual Rifle Qualification				
Labor Day	9/2/14 (Tues) 0430-0830 (10 Officers)	9/3/14 (Wed) 0430-0830 (7)	9/4/14 (Thurs) 0430-0830 (7)	9/5/14 (Fri) 0430-0830 (15)
9/8/14 (Mon) 1830-2230 (19 Officers)	9/9/14 (Tues) 1830-2230 (12)	9/10/14 (Wed) 1830-2230 (9)	9/11/14 (Thurs) 1830-2230 (4)	9/12/14 (Fri) 1630-2230 (20 Officers)
Fayetteville PD's Pistol Annual Firearms Qualification				
10/6/14 (Mon) 0430-1030 (15x Officers)	10/7/14 (Tues) 0430-1030 (16)	10/8/14 (Wed) 0430-1030 (6)	10/9/14 (Thurs) 0430-1030 (10)	10/10/14 (Fri) 0430-1030 (20)
10/13/14 (Mon) 1630-2230 (21 Officers)	10/14/14 (Tues) 1630-2230 (21)	10/15/14 (Wed) 1630-2230 (20)	10/16/14 (Thurs) 1630-2230 (18)	10/17/14 (Fri) 1630-2230 (16)
10/20/14 (Mon) 0430-1030 (11 Officers)	10/21/14 (Tues) 0430-1030 (10)	10/22/14 (Wed) 0430-1030 (12)	10/23/14 (Thurs) 0430-1030 (0)	10/24/14 (Fri) 0430-1030 (11)
10/27/14 (Mon) 1630-2230 (19 Officers))	10/28/14 (Tues) 1630-2230 (18)	10/29/14 (Wed) 1630-2230 (13)	10/30/14 (Th) 1630-2230 (0)	10/31/14 (Fri) 1630-2230 (12)

# Noise Test Results

Location of Test:	TigerSwan Range Complex (TRC) and vicinity
Firing Location:	TRC, Range C
Date:	13-Apr-12
Weather Conditions:	Clear, cool, 56 degrees Fahrenheit
Sound Instrument:	Sound Track LXT 1, Serial Number 045119
A1 Agricultural Zone Allowable Noise Limits:	75 db and a maximum of 90 db from the hours of 6:00 a.m. to 10:00 p.m.

Weapon	Noise Reading Location	Time	Lowest Noise Level	Highest Noise Level (db)	Average Noise Level
Glock, 9mm Rifle, 5.56	TRC, Range C	9:04 a.m.	78.4	79.2	78.8
			75.1	77.2	76.1
Glock, 9mm Rifle, 5.56	Deer Stand on TigerSwan Drive	9:17 a.m.	50.3	51	50.6
			57.5	58.2	57.8
Glock, 9mm Rifle, 5.56	Doe Hill Road / TigerSwan Drive	9:24 a.m.	49.9	50.1	50.0
			54.7	55.2	54.9
Glock, 9mm Rifle, 5.56	6504, Highway 210	9:04 a.m.	51.0	52.4	51.7
			52.0	52.3	52.1

Noise level on TRC

Noise level off TRC



# OSHA Noise Chart

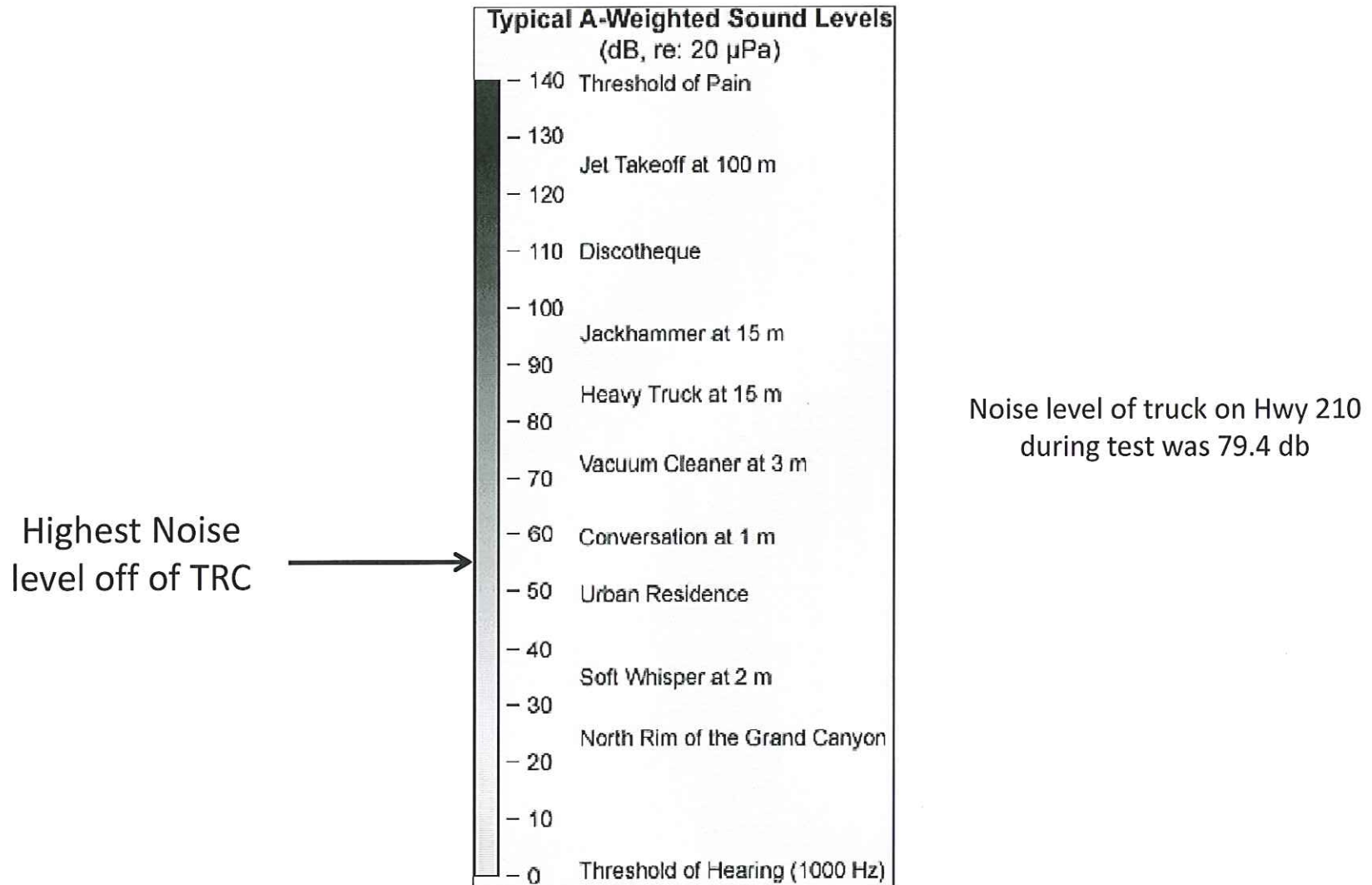

Source: <https://www.osha.gov/SLTC/noisehearingconservation/index.html>

Note: Highest noise level off of TRC is 55.2 db (Rifle) and 52.4 (Pistol)

# Comparison Noise Chart

Misc: Noise level of a truck on Hwy 210 was 79.4 db

From SoundBytes website: <http://www.soundbytes.com/page/SB/CTGY/decibel-levels>

Highest Noise  
level off of TRC

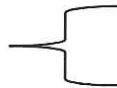

Decibel level	Event
10 dB	Normal breathing
20 dB	Rustling leaves, mosquito
30 dB	Whisper
40 dB	Stream, refrigerator humming
50-60 dB	Quiet office
50-65 dB	Normal conversation
60-65 dB	Laughter
70 dB	Vacuum cleaner, hair dryer
75 dB	Dishwasher
78 dB	Washing machine
80 dB	Garbage disposal, city traffic noise
84 dB	Diesel truck
70-90 dB	Recreational vehicle
88 dB	Subway, motorcycle
85-90 dB	Lawnmower
100 dB	Train, garbage truck
97 dB	Newspaper press
98 dB	Farm tractor

Note: Highest noise level off of TRC is 55.2 db (Rifle) and 52.4 (Pistol)



# The Range Complex (TRC) Request

**TRC requests an exception to the night firing rules imposed by the Cumberland County Commissioners for 3 months each year to support Fayetteville Police Departments annual pistol and rifle qualifications.**